

User Guide

hTC EVO™ 4G

www.sprint.com

*©2010 Sprint. SPRINT and the logo are trademarks of Sprint.
Other marks are the property of their respective owners.*

5/3/10



Note: Para encontrar esta guía para usuarios en español, por favor visita a www.sprint.com y haz clic en **Support > Phones & Devices**.

To find this user guide in Spanish, please visit www.sprint.com and click **Support > Phones & Devices**.

Important Privacy Message – Sprint's policies often do not apply to third-party applications. Third-party applications may access your personal information or require Sprint to disclose your customer information to the third-party application provider. To find out how a third-party application will collect, access, use, or disclose your personal information, check the application provider's policies, which can usually be found on their website. If you aren't comfortable with the third-party application's policies, don't use the application.

Table of Contents

Tip: Looking for something? If you don't see it in the headings listed here, try the **Index** on page 185.

Introduction	i
Your Device's Menu	i
Section 1: Getting Started	1
1A. Setting Up Service	2
Setting Up Your Device	2
Activating Your Device	2
Setting Up Your Voicemail	3
Sprint Account Passwords	3
Getting Help	4
Section 2: Your Device	5
2A. Device Basics	6
Your Device	6
Turning Your Device On and Off	8
Viewing the Display Screen	9
Battery and Charger	12
Getting Around Your Device	13
Displaying Your Phone Number	14
Making and Answering Calls	15
Speed Dialing	19
Dialing Sprint Services	19
Entering Text	19
Home Screen	22
2B. Settings	26
Personalization Settings	26
Sound Settings	27
Display Settings	29
Location Settings	30
Messaging Settings	31
Airplane Mode	32
TTY Use With Sprint Service	32
Security Settings	33
Data Synchronization Settings	34
Social Network Settings	35
Application Settings	36

Date & Time Settings	37
Locale & Text Settings	37
Power-Saving Tips	37
2C. History	39
Viewing History	39
Making a Call From History	39
Saving a Number From History	40
Prepending a Number From History	40
Erasing History	40
2D. People	41
About People	41
Using the People Screen	42
Adding a New People Entry	43
Saving a Phone Number	44
Using the Contact Details Screen	44
Merging Entries in People	45
Editing an Entry in People	45
Finding Entries in People	47
Backing Up and Importing Entries in People	48
Working with Groups	48
Using the People Widget	49
Connecting with Your Social Networks	50
Using Friend Stream	52
2E. Calendar and Tools	54
Calendar	54
Calculator	59
Clock	59
Quickoffice	63
PDF Viewer	64
HTC Sync	65
Updating Your Device	68
2F. Voice Services	69
Automatic Speech Recognition (ASR)	69
Managing Voice Memos	70
2G. microSD Card	72
Your Device's microSD Card	72
Using the Device's microSD Card as a USB Drive	74
2H. Camera and Multimedia	75
Taking Pictures and Shooting Videos	75
Viewing Pictures and Videos Using Gallery	81
Sharing Live Videos with Qik	88
Listening to Music	88
Listening to the Radio	92

2I. Bluetooth	94
Using Bluetooth	94
Section 3: Sprint Service	99
3A. Sprint Service: The Basics	100
Voicemail	100
Text Messaging (SMS) and Multimedia Messaging (MMS)	102
Caller ID	108
Call Waiting	108
Making a 3-Way Call	108
Call Forwarding	108
Roaming	109
3B. Web and Data Services	111
Ways of Connecting to the Internet	111
Connecting Using Wi-Fi	111
Connecting Using Sprint 4G	113
Getting Started With Data Services	114
Connecting to a Virtual Private Network (VPN)	115
Using the Device's Web Browser	116
Accessing Email Messages	122
Google Talk	131
Downloading Applications and Games From Android Market	136
Peep	138
Stocks	140
Weather	141
News Feeds	143
Sprint Mobile Hotspot	145
Using Your Device as a Modem (Internet Sharing)	147
Data Services FAQs	147
3C. Entertainment: TV and Music	148
TV	148
Music - MP3 Store	150
Streaming Music	150
YouTube	151
NASCAR Sprint Cup Mobile	152
3D. GPS Navigation	155
GPS Services	155
Sprint Navigation	155
Google Maps	156
Google Latitude	160
Footprints	163

Section 4: Safety and Warranty Information	165
4A. Important Safety Information	166
Important Health Information and Safety Precautions	166
General Precautions	170
Additional Safety Information	172
4B. Regulatory Notices	176
Regulatory Agency Identifications	176
Federal Communication Commission Interference Statement	176
SAR Information	178
Telecommunications & Internet Association (TIA) Safety Information	179
WEEE Notice	180
RoHS Compliance	180
4C. Manufacturer's Warranty	181
Manufacturer's Warranty	181
Privacy Restrictions	182
Weather Disclaimer	183
Warranty Disclaimer	183
Limitation of Damages	183
4D. Copyright, Trademark, and Proprietary Notices	184
Index	185

Introduction

This **User Guide** introduces you to Sprint® service and all the features of your new device. It's divided into four sections:

- ◆ Section 1: Getting Started
- ◆ Section 2: Your Device
- ◆ Section 3: Sprint Service
- ◆ Section 4: Safety and Warranty Information

WARNING: Please refer to the **Important Safety Information** section on page 166 to learn about information that will help you safely use your device. Failure to read and follow the Important Safety Information in this device guide may result in serious bodily injury, death, or property damage.

Your Device's Menu

The following table outlines your device's main menu structure. From the Home screen, press  to open the menu.

All apps
Scenes
1: Sprint Scene
2: HTC
3: Social
4: Work
5: Play
6: Travel
7: Clean Slate
Add to Home
1: Widget
2: Program
3: Shortcut
1: Bookmark 2: Direct Dial 3: Direct Message 4: Directions & Navigation 5: Gmail label 6: Mail Inbox 7: Music playlist 8: Person 9: Settings
4: Folder
1: New Folder 2: All People 3: Bluetooth Received 4: Facebook Phonebook 5: Phones 6: Starred
Wallpaper
Notifications
Settings
1: Personalize
1: Scenes
2: Home wallpaper
3: Default ringtone
2: Wireless & networks
1: Airplane mode
2: Wi-Fi
3: Wi-Fi settings
1: Wi-Fi 2: Network notification 3: Add Wi-Fi network

4: Bluetooth
5: Bluetooth settings
1: Bluetooth 2: Device name 3: Discoverable 4: Advanced Settings 5: Scan for devices
6: Sprint Hotspot
7: Sprint Hotspot settings
8: 4G
9: 4G settings
1: 4G 2: Network notification 3: Network provider 4: Signal strength 5: IP address
10: VPN settings
1: Add VPN
11: Mobile network
12: Mobile networks
1: Data roaming 2: Data Roam Guard 3: Data roaming sound 4: Enable always-on mobile data 5: Roaming 6: Call guard
13: Internet sharing
3: Call
1: Voicemail service
2: Voicemail settings
3: Clear voicemail notification
4: TTY mode
1: TTY Off 2: TTY Full 3: TTY HCO 4: TTY VCO
5: Hearing aids
6: Phone settings
1: Edit default message 2: Edit message 3: Save to contacts
7: DDTM mode
8: Voice Privacy
9: Automatic prepend
10: Plus code dialing
1: North American dialing 2: International dialing
4: Sound & display
1: Sound profile 2: Ringer volume 3: Media volume 4: Phone ringtone 5: Phone vibrate 6: Notification sound 7: Quiet ring on pickup 8: Audible touch tones 9: Audible selection 10: Haptic feedback 11: SD card notifications 12: Roaming ringtone 13: Emergency tone 14: Orientation 15: Animation 16: Brightness 17: Screen timeout 18: Notification flash 19: G-Sensor calibration
5: Accounts & sync
1: Background data
2: Auto-sync
3: Exchange ActiveSync (if you have set up an Exchange ActiveSync email account)
1: Account settings 2: Schedule 3: Mail 4: Contacts 5: Calendar
4: Facebook for HTC Sense (if you have logged in to your Facebook account)
1: Account settings 2: Sync Contacts
5: Google (if you have set up a Google Account)
1: Sync Contacts 2: Sync Gmail 3: Sync Calendar
6: Twitter (if you have logged in to your Twitter account)
1: Account settings 2: Sync Peep 3: Sync Friend
7: Weather
1: Account settings 2: Sync weather data
6: Location
1: Use wireless networks 2: Location setting 3: Use GPS satellites
7: Search
1: Google search settings 2: Searchable items 3: Clear search shortcuts

8: Privacy			
1: Use My Location	2: Factory data reset		
9: Connect to PC			
1: Default connection type 2: Ask me			
10: Security			
1: Set unlock pattern			
2: Require pattern			
3: Use visible pattern			
4: Use tactile feedback			
5: Visible passwords			
6: Set password			
7: Use secure credentials			
8: Install from SD card			
9: Clear storage			
11: Applications			
1: Unknown sources	2: Manage applications	3: Running services	4: Development
12: SD & phone storage			
1: Total space	2: Available space	3: Unmount SD card	4: Format SD card
5: Available space			
13: Date & time			
1: Automatic	2: Set date	3: Select time zone	4: Set time
5: Use 24-hour format	6: Select date format		
14: Language & keyboard			
1: Select locale			
2: Touch Input			
1: Keyboard types	2: Keyboard language	3: Text input	4: Tutorial
5: User Dictionary			
15: Accessibility			
16: Text-to-speech			
1: Listen to an example	2: Install voice data	3: Always use my settings	4: Speech rate
5: Language			
17: System updates			
1: Firmware update	2: Update profile	3: Update PRL	4: HTC software update
18: About phone			
1: Network			
1: Operator name	2: Signal strength	3: Mobile network type	4: Service state
5: Roaming	6: Current username		
2: Phone identity			
1: Model number	2: MEID	3: Phone number	4: IMSI
3: Battery			
1: Battery status	2: Battery level	3: Battery use	4: Up time
5: Awake time			
4: Hardware information			
1: Hardware version	2: Wi-Fi MAC address	3: Bluetooth address	4: 4G MAC address
5: Software information			
1: Firmware version	2: Baseband version	3: Kernel version	4: Build number
5: Software number	6: Browser version	7: PRL Version	8: PRL Version
6: Legal information			
1: HTC legal	2: Sprint legal	3: Google legal	4: Open source licenses

Tip: For most programs or games on the device, pressing  brings up options available for the application or game.

Section 1
Getting Started



1A. Setting Up Service

- ◆ Setting Up Your Device (page 2)
- ◆ Activating Your Device (page 2)
- ◆ Setting Up Your Voicemail (page 3)
- ◆ Sprint Account Passwords (page 3)
- ◆ Getting Help (page 4)

Setting Up Your Device

1. Install the battery:



- Insert your fingernail into the slot at the top left of the battery compartment cover and lift gently to remove.
- Align the battery's exposed copper contacts with the battery connectors inside the battery compartment.
- Insert the contact end of the battery first then gently push the battery into place.
- Replace the back cover making sure all the locking tabs are seated and there are no gaps around the cover.

2. Press () to turn the device on (black button located at the top of the device and on the right).

Note: When you turn on your device for the first time, you will be given options to let you quickly set up various accounts, such as Google™ account, Facebook™, Flickr®, Twitter™, Microsoft® Exchange ActiveSync, and other email accounts. We recommend that you skip these.

- If your device is activated, it will turn on, search for Sprint service, and enter standby mode.
- If your device is not yet activated, see “Activating Your Device” on page 2 for more information.

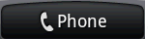
3. Make your first call.

- Tap .
- Use the onscreen keypad to enter a phone number.
- Tap .

Note: Your device's battery should have enough charge for your device to turn on and find a signal, set up your voicemail, and make a call. You should fully charge your battery as soon as possible. See “Charging the Battery” on page 13 for details.

Activating Your Device

- **If you purchased your device at a Sprint Store**, it is probably activated and ready to use.
- **If you received your device in the mail and it is for a new Sprint account or a new line of service**, it is designed to activate automatically. To confirm your activation, make a phone call.
- **If you received your device in the mail and you are activating a new device for an existing number on your account**, you will need to go online to activate your new device.
 - From your computer's Web browser, go to www.sprint.com/activate and complete the onscreen instructions to activate your device.



When you have finished, make a phone call to confirm your activation. If your device is still not activated or you do not have access to the Internet, contact Sprint Customer Service at **1-888-211-4727** for assistance.

Tip: Do not press  while the device is being activated. Pressing  cancels the activation process.

Note: If you are having difficulty with activation, contact Sprint Customer Service by dialing **1-888-211-4727** from any other phone.

Setting Up Your Voicemail

Your device automatically transfers all unanswered calls to your voicemail, even if your device is in use or turned off. You should set up your Sprint Voicemail and personal greeting as soon as your device is activated.

1. Press  and tap  > **Voicemail**.
2. In the Personalize your Voicemail window, tap **Personalize now**.
3. Your device will automatically connect with Sprint Voicemail service. Follow the voice prompts to:
 - Create your passcode.
 - Record your name announcement.
 - Record your greeting.

Note: Voicemail Passcode

Sprint strongly recommends that you create a passcode when setting up your voicemail to protect against unauthorized access. Without a passcode, anyone who has access to your handset is able to access your voicemail messages.

For more information about using your voicemail, see “Voicemail” on page 100.

Sprint Account Passwords

As a Sprint customer, you enjoy unlimited access to your personal account information, your voicemail account, and your data services account. To ensure that no one else has access to your information, you will need to create passwords to protect your privacy.

Account Username and Password

If you are the account owner, you will create an account username and password when you sign on to www.sprint.com. (Click **Need to register for access?** to get started.) If you are not the account owner (if someone else receives the bill for your Sprint service), you can get a sub-account password at www.sprint.com.

Voicemail Password

You'll create your voicemail password (or passcode) when you set up your voicemail. See Setting Up Your Voicemail for more information on your voicemail password.

Data Services Password

With your Sprint device, you may elect to set up an optional data services password to control access and authorize Premium Service purchases.

For more information, or to change your passwords, sign on to www.sprint.com or call Sprint Customer Service at **1-888-211-4727**.

Getting Help

Managing Your Account









Online: www.sprint.com

- Access your account information.
- Check your minutes used (depending on your Sprint service plan).
- View and pay your bill.
- Enroll in Sprint online billing and automatic payment.
- Purchase accessories.
- Shop for the latest Sprint phones.
- View available Sprint service plans and options.
- Learn more about data services and other products like Sprint Picture Mail, games, ringers, screen savers, and more.

From Your Sprint Device

1. From the Home screen, tap .

2. Do any of the following:

- Tap    to check minute usage and account balance.
- Tap    to make a payment.
- Tap    to access a summary of your Sprint service plan or get answers to other questions.

From Any Other Phone

- Sprint Customer Service: **1-888-211-4727**.
- Business Customer Service: **1-800-927-2199**.

Sprint 411

Sprint 411 gives you access to a variety of services and information, including residential, business, and government listings; movie listings or showtimes; driving directions, restaurant reservations, and major local event information. You can get up to three pieces of information per call, and the operator can automatically connect your call at no additional charge.

There is a per-call charge to use Sprint 411, and you will be billed for airtime.

▶ Tap    .

Sprint Operator Services

Sprint Operator Services provides assistance when you place collect calls or when you place calls billed to a local telephone calling card or third party.

▶ Tap  .



For more information or to see the latest in products and services, visit us online at www.sprint.com.

Section 2
Your Device



2A. Device Basics

- ◆ Your Device (page 6)
- ◆ Turning Your Device On and Off (page 8)
- ◆ Viewing the Display Screen (page 9)
- ◆ Battery and Charger (page 12)
- ◆ Getting Around Your Device (page 13)
- ◆ Displaying Your Phone Number (page 14)
- ◆ Making and Answering Calls (page 15)
- ◆ Speed Dialing (page 19)
- ◆ Dialing Sprint Services (page 19)
- ◆ Entering Text (page 19)
- ◆ Home Screen (page 22)

Tip: Device Software Upgrades – Updates to your device's software may become available from time to time. Sprint will automatically upload critical updates to your device. You can also check for and download updates by pressing  > , and then tapping **Settings** > **System updates** > **Firmware update** to search for and download available updates.

Your Device

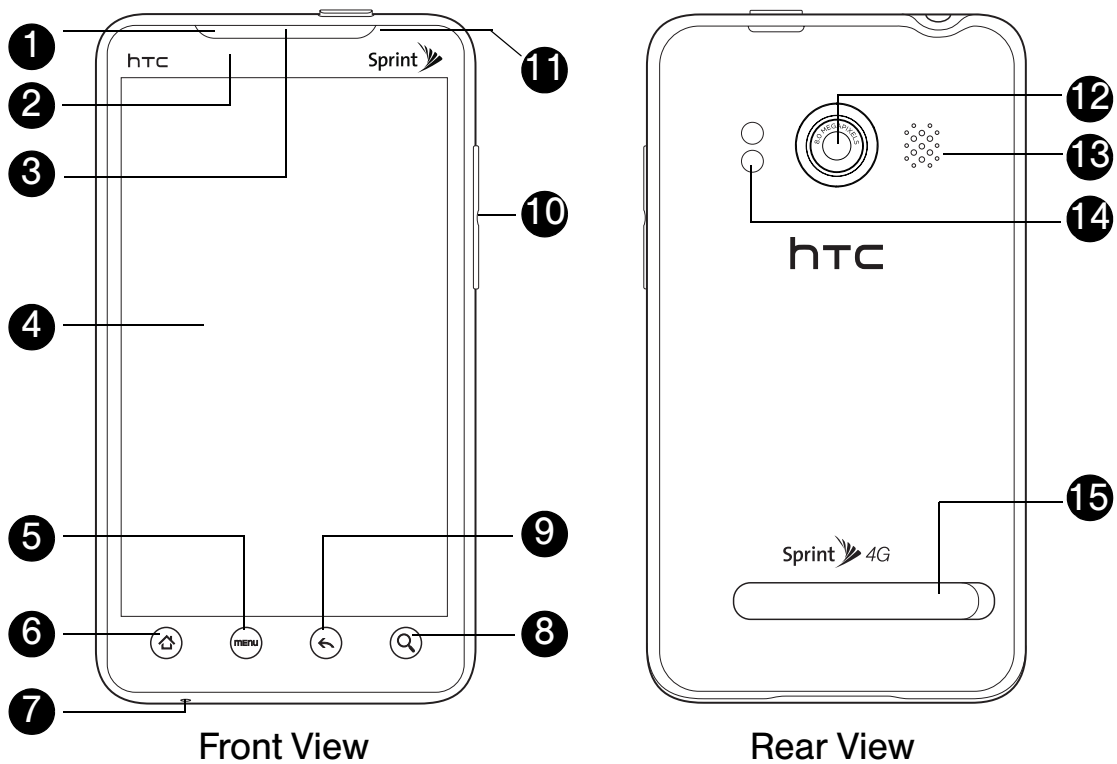

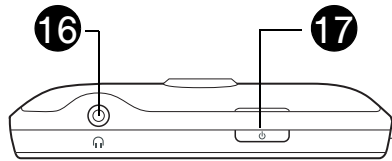

Top View

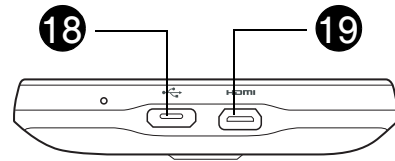

End View

Key Functions

1. **Front Indicator Light (LED)** shows your device's connection status at a glance.
2. **Proximity Sensor** automatically switches the display screen off when you hold the device near your face during a call. When activated, the proximity sensor does not reduce transmission power for WiMAX, CDMA, or Wi-Fi.
3. **Earpiece** lets you hear the caller and automated prompts.
4. **Display Screen** displays all the information needed to operate your device, such as the call status, the People list, the date and time, and the signal and battery strength.
5. **Menu Key** allows you to open a list of actions that you can do on the current screen.
6. **Home Key** takes you back to the Home screen. When in standby mode, press and hold to open the recently-used applications window.
7. **Microphone** allows other callers to hear you clearly when you are speaking to them.
8. **Search Key** allows you to search information on the current screen or application. For example, while in People, press  to search for a contact in the device.
9. **Back Key** allows you to go back to the previous screen, or close a dialog box, options menu, the Notifications panel, or onscreen keyboard.
10. **Volume Button** allows you to adjust the ringer or media volume or adjust the voice volume during a call.
11. **Front Camera** lets you capture a self-portrait or a video.
12. **Camera Lens** as part of the built-in camera, lets you take pictures and videos.
13. **Speaker** lets you hear the different ringers and sounds. The speaker also lets you hear the caller's voice in speakerphone mode.
14. **Dual Flash** helps illuminate subjects in low-light environments when the camera is focusing and capturing a photo or video.
15. **Kickstand** lets you prop up the device on a desk or other flat surface for more comfortable viewing.
16. **3.5 mm Headset Jack** allows you to plug in either a stereo headset or an optional headset for convenient, hands-free conversations. CAUTION! Inserting an accessory into the incorrect jack may damage the device.
17. **Power Button** lets you turn the device on or off or turn on/off the screen. While in standby mode and the screen is unlocked, press and hold to open a menu to let you turn on/off the device, turn on/off your mobile network connection, or switch your device to silent mode, vibration mode, or airplane mode.
18. **Charger/Accessory Jack** allows you to connect the device charger or the USB cable (included). CAUTION! Inserting an accessory into the incorrect jack may damage the device.
19. **HDMI Jack** allows you to use an HDMI cable to connect to an HDMI-capable external display, such as an LCD TV. You can then display photos and videos on your device to the connected external display. CAUTION! Inserting an accessory into the incorrect jack may damage the device.

Turning Your Device On and Off

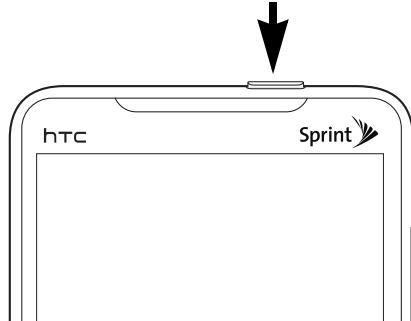

Turning Your Device On

- ▶ Press the power button () at the top panel of the device.



Turning Your Device Off

1. Press and hold  for about two seconds.



Note: When the screen is locked and you press , it will only turn off the screen and not the device. You will need to unlock the screen first before you press and hold . See "Turning Off the Screen When Not in Use" for details.

2. On the **Phone options** menu, tap **Power off**.
3. On the **Power off** confirmation box, tap **OK**.

Turning Off the Screen When Not in Use

To save battery power, the device automatically turns off the screen when you leave it idle after a certain period of time. You will still be able to receive messages and calls while the device's screen is off.

Tip: For information on how to adjust the time before the screen turns off, see "Display Settings" on page 29.

You can also turn off and lock the screen by pressing . Pressing  again or incoming calls will turn on your device screen and show the lock screen.

To unlock the screen:



Press and hold the lock screen bar and then slide your finger down to unlock the screen or answer an incoming call.







Note: If you have set up a screen unlock pattern, you will be prompted to draw the pattern on the screen before it unlocks. For more information on how to create and enable the screen unlock pattern, see “Protecting Your Device with a Screen Lock” on page 33.

Viewing the Display Screen

























Your device’s display screen provides information about notifications and your device’s status. This list identifies the symbols you’ll see on your device’s display screen:



Status Bar – Notification Icons			
	New Text or Multimedia Message		More (undisplayed) notifications
	New Voicemail		Call in progress (Voice Privacy locked/unlocked)
	New Gmail message		Missed call
	New Microsoft Exchange ActiveSync or POP3/IMAP email message		Compass needs orientation
	Problem with Text/Multimedia Message delivery		Uploading data (animated)
	New instant message from Google Talk		Downloading data (animated)
	Upcoming event		Waiting to upload
	Music is playing		Content downloaded
	General notification (for example, sync error)		Device connected to computer via USB cable
	Storage card is low on free space		Storage card is safe to remove or storage card is being prepared
	Wi-Fi is on and wireless networks are available		No storage card installed on the device.

Status Bar – Notification Icons			
	Data synchronizing – connected to HTC Sync		New tweet
	New location detected		Updates available for an application downloaded from Android Market



Status Bar – Device Status Icons			
	Signal Strength (More bars = stronger signal)		Shows current battery charge level (Icon shown is fully charged)
	No Service		Bluetooth on
	Device is “roaming” off the Nationwide Sprint Network		Connected to Bluetooth device
	Sprint 3G data service (EVDO) available (when active, icon animated)		Airplane mode
	Sprint 1xRTT network available (when active, icon animated)		Alarm set
	Data service is currently unavailable		Speakerphone on
	Device’s location feature is on and available for location-based services such as GPS Navigation		Wired microphone headset connected
	Device’s location feature off and your location available only for 911 (page 17)		Wired headset connected
	Device microphone muted		Connected to Wi-Fi network
	Device speaker muted		Connected to a 4G network
	Vibrate mode		4G is on and 4G networks are available
	Sprint Mobile Hotspot is on and is ready to share its 4G connection		Sprint Mobile Hotspot is on and is ready to share its 3G connection

Notifications Panel

Notification icons report the arrival of new messages, calendar events, alarms being set and ongoing settings such as call forwarding being on or the current call status. You can open the Notifications panel to access message, reminder, or event notification tabs.

To open the Notifications panel:

When a new notification icon displays in the status bar, press and hold the status bar, and then slide your finger downward to open the Notifications panel.

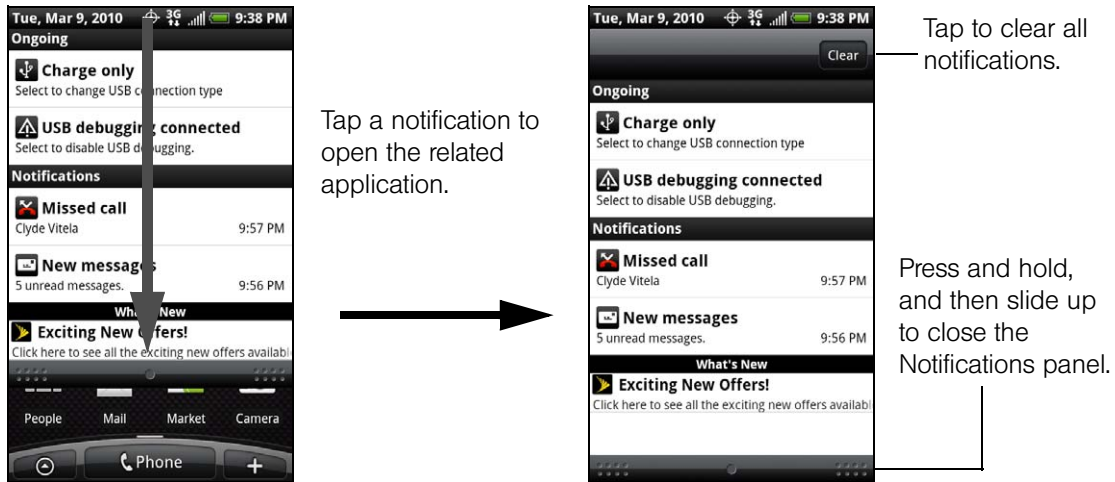

If you have several notifications, you can scroll down the screen to view more notifications.

Tip: You can also open the Notifications panel from the Home screen by pressing  and then tapping **Notifications**.

To close the Notifications panel:

- ▶ Press and hold the bottom bar of the Notifications panel, and then slide your finger up the screen.
- or –
- Press .

Notification LED

The Notification LED located at the right corner of the earpiece provides information on the device status or pending notifications.

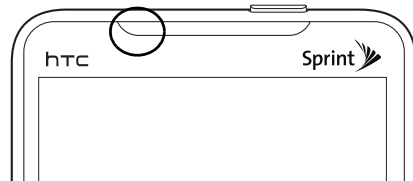

LED Status	Indication
Solid green	Battery is fully charged. (When the device is connected to the AC adapter/computer.)
Solid amber	Battery is charging.
Flashing amber	Battery is low. (Battery power is below 14%.)
Flashing green	You have a pending notification (for example, a new message or a missed call).

Note: The indicators are listed in order of priority. For example, if your device is connected to a power adapter and is charging the battery, the LED will be solid amber and will not switch to a flashing green light even if there is a pending notification.

Battery and Charger

WARNING: Use only Sprint-approved or HTC-approved batteries and chargers with your device. The failure to use an Sprint-approved or HTC-approved battery and charger may increase the risk that your device will overheat, catch fire, or explode, resulting in serious bodily injury, death, or property damage.

Sprint-approved or HTC-approved batteries and accessories can be found at Sprint Stores or through HTC; or call **1-866-866-7509** to order. They're also available at www.sprint.com.

Battery Capacity

Your device is equipped with a Lithium Ion (Li-Ion) battery. It allows you to recharge your battery before it is fully drained. The battery provides up to 6 hours of continuous talk time. For battery-saving tips, see "Power-Saving Tips" on page 37.

Note: Long backlight settings, searching for service, vibrate mode, browser use, and other variables may reduce the battery's talk and standby times.

Tip: Watch your device's battery level indicator and charge the battery before it runs out of power.

Installing the Battery

1. With the device turned off, insert your fingernail into the slot at the top left of the battery compartment cover and lift gently to remove.

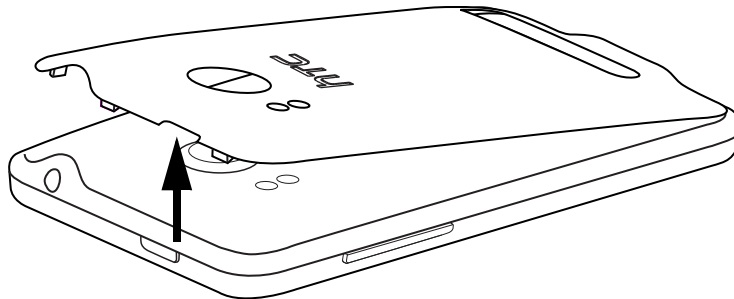

2. Align the battery's exposed copper contacts with the battery connectors inside the battery compartment.
3. Insert the contact end of the battery first then gently push the battery into place.

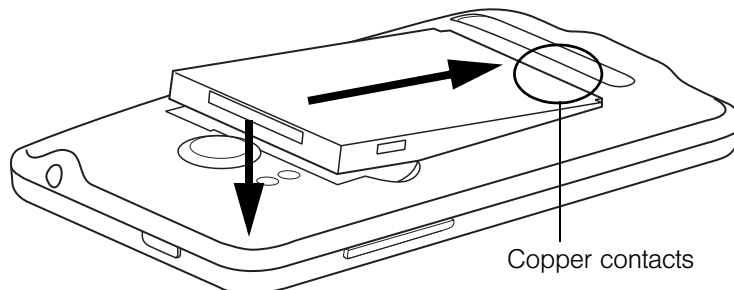

4. Replace the back cover, making sure all the locking tabs are seated and there are no gaps around the cover.

Removing the Battery

1. Make sure the power is off so that you don't lose any stored numbers or messages.
2. Remove the back cover. (See step 1 of "Installing the Battery.")
3. Lift the battery from the notches on the upper left and right sides of the battery compartment.

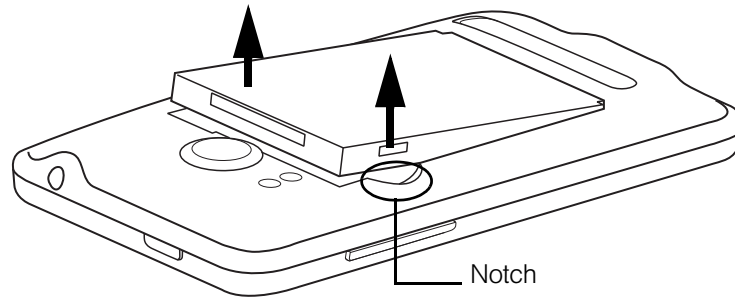



WARNING: Do not handle a damaged or leaking Li-Ion battery as you can be burned.

Charging the Battery

Keeping track of your battery's charge is important. If your battery level becomes too low, your device automatically turns off, and you will lose any information you were just working on.

Always use a Sprint-approved or HTC-approved desktop charger, travel charger, or vehicle power adapter to charge your battery.

1. Plug the USB connector of the AC adapter into the charger/accessory jack at the bottom of your device.
2. Plug in the AC adapter to an electrical outlet to start charging the battery.

Charging is indicated by a solid amber light in the Notification LED. As the battery is being charged while the device is on, the charging battery icon () is displayed in the status bar of the Home screen. After the battery has been fully charged, the Notification LED shows a solid green light and a full battery icon () displays in the status bar of the Home screen.

For more information about Notifications, see "Notification LED" for more details.

With the Sprint-approved Li-Ion battery, you can recharge the battery before it becomes completely run down.

Getting Around Your Device

There are different ways to navigate around the your device's Home screen, menus, and application screens.

Tap

When you want to type using the onscreen keyboard, select items onscreen such as application and settings icons, or press onscreen buttons, simply tap them with your finger.

Press and hold

To open the available options for an item (for example, contact or link in a Web page), simply press and hold the item.

Swipe or slide

To swipe or slide means to quickly drag your finger vertically or horizontally across the screen.

Drag



To drag, press and hold your finger with some pressure before you start to move your finger. While dragging, do not release your finger until you have reached the target position.

Flick

Flicking the screen is similar to swiping, except that you need to swipe your finger in light, quick strokes. This finger gesture is always in a vertical direction, such as when flicking the contacts or message list.

Rotate

For most screens, you can automatically change the screen orientation from portrait to landscape by turning the device sideways. When entering text, you can turn the device sideways to bring up a bigger keyboard. See “Using the Onscreen Keyboard” for more details.

Note: The **Orientation** check box in  >  > **Settings** > **Sound & display** needs to be selected for the screen orientation to automatically change.

Pinch



The device screen supports multi-touch. On the Home screen, you can “pinch” the screen using two fingers (for example, thumb and index fingers) to switch to thumbnail view and see all the Home screens. For some applications, like Gallery or the browser, pinch the screen to zoom in or zoom out when viewing a picture or a Web page.

Navigation keys

If the onscreen keyboard is open, tap the navigation keys to go to a text box or an area on the screen.



Displaying Your Phone Number

- ▶ Press  >  and tap **Settings** > **About phone** > **Phone identity**. (Your phone number and other information about your device and account will be displayed.)

Making and Answering Calls





Making Calls

There are several convenient methods to make a call from your device.

Calling Using the Phone Dialer

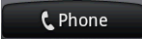
In the Phone's dialer, you can either dial a number directly, or you can use the **Smart Dial** feature to search and call a contact in People or a number from Call History.



When you enter the first letter of the name or number of a contact, Smart Dial searches for contact phone numbers and the first character of a contact name as well as from the character that appears after a space, dash, or underscore in a contact name. As you enter more letters or numbers, the list shows only the corresponding matches.

1. Press  and tap .
2. Begin entering the first few digits or characters by tapping the keys on the Phone keypad. As you enter digits or letters, the Smart Dial panel displays matches found. If you enter a wrong digit, tap  to erase that digit. To erase the entire number, press and hold .
3. Tap  to close the Phone keypad and to see if there are more matching numbers or contacts. To browse through the filtered list, flick through the list or slide your finger up or down the list slowly.
4. Tap the phone number or contact from the list.
– or –

To call a different phone number associated with the contact, tap the contact card icon at the right side of the contact name. On the contact details screen, tap the number you want to call.

Calling a Phone Number in a Text Message

While viewing a text message, you can place a call to a number that is in the body of the message.

1. Press , and then tap  > **Messages**.
2. Tap the message with the phone number, and then tap the phone number.
3. On the **Select link** screen, tap the number you want to call.
4. The Phone screen then opens, with the phone number automatically filled in and ready to be dialed. To place the call, tap **Call**.

For more information about text messages, see “Text Messaging (SMS) and Multimedia Messaging (MMS)” on page 102.

Calling a Phone Number in an Email Message

While viewing a received email message, tap a phone number that is displayed in the body of the email message to open the Phone screen so you can call that number.

Calling a Speed Dial Number

To call a stored speed dial number, press and hold a number button. For information on setting up speed dial numbers, see “Speed Dialing” on page 19.

You can also place calls from your device using your History listings (page 39) and Automatic Speech Recognition (page 69).

Receiving Calls

When you receive a phone call from a contact, the Incoming call screen appears and displays the caller ID icon, name, and phone number of the calling party. When you receive a phone call from someone who is not stored in People, only the default caller ID icon and phone number appear on the Incoming call screen.

Note: Make sure your device is on. (If your device is off, incoming calls go to voicemail.)

Answering an Incoming Call

- ▶ If the display is on, tap **Answer**.
- ▶ If the display is off, the display will turn on showing the Lock screen. Drag the bar down to answer the call.



Muting the Ringing Sound

To mute the ring without rejecting the call, you can do any of the the following:

- ▶ Press the volume down button.
- ▶ Press  and tap **Mute**. (You can do this even on the Lock screen.)
- ▶ Place the device face down on a level surface.

Using the Quiet Ring on Pickup Feature

Your device automatically scales down the ring volume when you pick up the device to answer calls.

1. Press  > , and then tap **Settings > Sound & display**.
2. Scroll down the screen, and then select the **Quiet ring on pickup** check box.
3. Press .

Rejecting an Incoming Call

- ▶ If the display is on, tap **Decline**.
- ▶ If the display is off, the display will turn on showing the Lock screen. Press  and then tap **Decline** to reject and send the call to your voicemail.

Rejecting a Call and Sending a Text Message

You can automatically send a default text message to the caller and reject the incoming voice call. Press  and tap **Send message** when you have an incoming call to send the text message.

You can change the default text message by pressing  and tapping **Phone settings > Edit default message** while on the Phone screen.

Answering a Roam Call With Call Guard Enabled

Call Guard is an option that helps you manage your roaming charges when making or receiving calls while outside the Nationwide Sprint Network. See “Roaming” on page 109 for more information.

- ▶ Tap **Answer** to answer the call. (See “Call Guard” on page 110 for more information.)

Note: When your device is off, calls go directly to voicemail.

Ending a Call

- ▶ Tap **End call**.

Missed Call Notification

When you do not answer an incoming call, you will see the missed call icon  in the status bar when you miss a call.





To check who the caller was, press and hold the status bar, and then slide your finger downward on the screen to open the Notifications panel. The missed call number or contact name is displayed.

Tap the missed call number or contact name to open the Call history. Missed calls are indicated by the missed call icon ().





Calling Emergency Numbers

You can place calls to 911 (dial    ), even if the device's screen is locked with a pattern or your account is restricted.

To call the 911 emergency number when the device's screen is locked with a pattern:

1. Unlock the screen. For more information, see “Turning Off the Screen When Not in Use.”
2. Tap **Emergency call** on the screen.
3. Tap    , and then tap  .

To call the 911 emergency number normally or when your account is restricted:

1. Unlock the screen. For more information, see “Turning Off the Screen When Not in Use.”
2. Tap  on the Home screen.
3. Tap    , and then tap  .

Enhanced 911 (E911) Information

This device features an embedded Global Positioning System (GPS) chip necessary for utilizing E911 emergency location services where available.

When you place an emergency 911 call, the GPS feature of your device seeks information to calculate your approximate location. Depending on several variables, including availability and access to satellite signals, it may take up to 30 seconds or more to determine and report your approximate location.

Important: Always report your location to the 911 operator when placing an emergency call.

Some designated emergency call takers, known as Public Safety Answering Points (PSAPs) may not be equipped to receive GPS location information from your device.

In-Call Options

Pressing  during a call displays a list of available in-call features. To select an option, tap the option. The following options may be available through the Options menu:

Note: When the device is completing a call, only the **People**, **Flash** and **Speaker on** options are available.

- **Add call** to initiate a three-way call.
- **People** to display your contacts list.
- **Flash** to accept another incoming call and put the first caller on hold. Tap **Flash** again to talk to the first caller.
- **Mute** to mute the microphone. Tap **Unmute** to unmute the microphone.
- **Speaker on** or **Speaker off** to route the device's audio through the speaker or through the earpiece.

- ▶ Tap **Speaker On** to route the device's audio through the speaker. (You can adjust the speaker volume using the volume button on the side of the device.)
- ▶ Tap **Speaker Off** to use the device's earpiece.

WARNING: Because of higher volume levels, do not place the device near your ear during speakerphone use.

End-of-Call Options



After you receive a call from or make a call to a phone number that is not in your People list, you can choose to save the number to People. On the Phone screen, tap  at the right side of the number to add the new number to People. (See "Saving a Phone Number" on page 18.)

Tip: After receiving a call from a phone number that is not in your People list, an options menu is briefly displayed to allow you to save the number to People. On the options menu, tap **Yes, create new contact**.

Saving a Phone Number



Store contacts entries in your device. Your device automatically sorts People entries alphabetically. (For more information, see "People" on page 41.)

To save a number from standby mode:



1. Press  and tap .
2. Enter the phone number by tapping the keys on the keypad.
3. Tap **Save to People**. (This button appears after tapping six digits.)
4. Tap **Create new contact** or **Save to existing contact**.
5. Use the keyboard to enter the new contact name and tap **Save** to save the new entry.
– or –
Tap an existing contact name and tap **Save** to save the new number.

Finding a Phone Number

You can search People for entries by name.

1. Press , tap  > **People**, and then press .
2. Enter the first letter or letters of an entry. (The more letters you enter, the more specific the search.)
3. Tap the contact to display his/her contact information.



Dialing From the People List

1. Press , tap  > **People**.
2. Tap the entry you want to call.
3. Tap **Call [Type of Number]**. (For example, **Call mobile**.)

Speed Dialing

Your device can store up to nine phone numbers in speed dial locations.

To assign a speed dial number to a People entry:

1. Press , tap  > **People**, and then tap an entry in People.
2. Press  and tap **More > Set speed dial**.
3. Tap the list menu under **Number** to select a number from the contact to assign to speed dial.
4. Tap the list menu under **Location** to assign the number to a speed dial location.
5. Tap **Save**.



Note: If you assign a number to an already in-use speed dial location, the new phone number will automatically replace the previous speed dial assignment.

To call using Speed Dial:

- ▶ Press and hold the appropriate key on the Phone keypad for approximately two seconds. The display confirms that you have dialed the number when it shows “Dialing” on the upper right side of the screen.

Note: Speed dialing is not available when you are roaming; when you are roaming off the Nationwide Sprint Network, you must always dial using eleven digits (1 + area code + number).













Finding Speed Dial Numbers

1. Press , tap .
2. Press  and tap **Speed dial**.
3. Tap a speed dial entry to call the contact.

Tip: While on the Speed dial screen, press  and tap **Add** to add new speed dial entries from People.

Dialing Sprint Services

- ▶ Dial the appropriate service number:

- **Customer Service** –   
- **Sprint 411** –    
- **Account Info.** –   
- **Sprint Operator** –  

Entering Text

Using the Onscreen Keyboard

When you start a program or select a box that requires text or numbers, the onscreen keyboard becomes available. You can choose from three keyboard layouts: **QWERTY**, **Compact QWERTY**, and **Phone Keypad**.

Using the Landscape Onscreen Keyboard

When entering text, you can choose to use the landscape orientation of the onscreen keyboard, by turning the device sideways, to use a larger keyboard that lets you type easily using two thumbs.

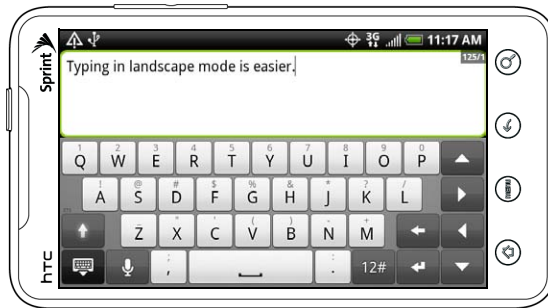

Note: The **Orientation** check box in > > **Settings** > **Sound & display** needs to be selected for the screen orientation to automatically change.

The landscape orientation keyboard is not supported in all applications.

Changing the Onscreen Keyboard Layout

You can choose from three different keyboard layouts to suit your typing style. To change the keyboard layout, do the following:

1. Press > , and then tap **Settings** > **Language & keyboard** > **Touch Input**.
2. Tap **Keyboard types**, and then select the keyboard layout that you want to use. Choose from the following:
 - **QWERTY**. This layout is similar to a desktop computer keyboard. This is the default keyboard layout.
 - **Phone Keypad**. This layout resembles the traditional wireless phone keypad.
 - **Compact QWERTY**. This layout features two letters on each key. The key size is slightly bigger than on the Full QWERTY layout.

Entering Text

Use the following keys while entering text using the onscreen keyboard:

	Press and hold keys with gray characters at the top to enter numbers, symbols, or accented letters. The gray character displayed on the key is the character that will be inserted when you press and hold that key. Some keys have multiple characters or accents associated with them.
	Shift key. Tap to enter an uppercase letter. The next letter you type will be uppercase. Tap twice to turn on caps lock.
	Tap to switch to the numeric and symbol keyboard.
	Enter key. Tap to create a new line.
	Backspace key. Tap to delete the previous character.
	Tap to hide the onscreen keyboard.
	Tap to toggle between Multitap and XT9 predictive modes when using the Compact QWERTY or Phone Keypad layout. (See “Entering Words with Predictive Text” for details.)

Entering Words with Predictive Text

The onscreen keyboard has predictive text to help you type quickly and accurately. Predictive text input is enabled by default, and word suggestions are displayed as you type.

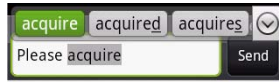

To enter a word in predictive mode, do any of the following:

- If you see the word you want highlighted in green or orange, you can simply tap the space bar to insert the word into your text.
- If you see the word you want shown in the suggestions before you have finished typing the entire word, tap the word to insert it into your text.
- If an arrow is shown to the right of the suggestion list, tap the arrow to see more suggestions.

Adding a Word to the Predictive Text Dictionary

Your device comes with a list of words that it references for predictive text suggestions. Sometimes you may need to add a word to the predictive text dictionary, for example a name or a specialized technical word. While entering text using the QWERTY keyboard layout, if you tap any word on the suggestion list, it is automatically added to the predictive text dictionary if it was not in the dictionary already.

To manually add a word to the predictive text dictionary:

1. Press > , and then tap **Settings > Language & keyboard > Touch Input > User Dictionary**.
2. Tap **Add new**.
3. Enter the word to add, and then tap **OK**.

Editing or Deleting a Word in the User Dictionary

You can edit or remove words that you previously added to the predictive text dictionary.

1. Press > , and then tap **Settings > Language & keyboard > Touch Input > User Dictionary**.
2. Do any of the following:
 - To edit a word, tap the word, enter your changes, and then tap **OK**.
 - To delete a word, tap the **X** icon to the right of the word.

Adjusting Touch Input Settings

- Press > , and tap **Settings > Language & keyboard > Touch Input**.

Touch Input Settings

- **Keyboard types** lets you select the keyboard layout to use. You can choose from **QWERTY**, **Phone Keypad**, or **Compact QWERTY**.
- **Keyboard language** lets you select the language layout of the keyboard.
- **Text input** lets you set text input options when entering text, calibrate the keyboard, and set a sound or vibration feedback whenever you tap a key.
 - QWERTY
 - **Prediction**: Enable the word prediction feature.
 - **Spell correction**: Correct typographical errors by selecting from a list of possible words that reflect the characters of the keys you have tapped as well as characters of nearby keys.

- Phone keypad & compact QWERTY
 - **Spell correction:** Correct typographical errors by selecting from a list of possible words that reflect the characters of the keys you have tapped as well as characters of nearby keys.
 - **Word completion:** Select from a list of possible combinations based on the characters that appear on the keys that you tapped.
- Other settings
 - **Sound feedback:** Make a clicking sound whenever you tap a key on the keyboard.
 - **Vibrate when typing:** Enable vibration feedback whenever you tap a key on the keyboard.
- Finger touch precision
 - **Calibration tool:** Recalibrate the keyboard touch accuracy. Recalibrate the keyboard if you feel that the keyboard keys are not responding accurately to your taps.
 - **Reset calibration:** Reset the calibration back to factory default.
- **Tutorial** lets you go through tutorials to learn how to use the onscreen keyboard features.
- **User Dictionary** lets you add, edit, or remove words in the predictive text dictionary. For more information, see “Adding a Word to the Predictive Text Dictionary” and “Editing or Deleting a Word in the User Dictionary.”

Home Screen

The Home screen is the starting point for many applications and functions, and it allows you to add items like application icons, shortcuts, folders, and HTC or Google widgets to give you instant access to information and applications.



1. **Status Bar:** Displays device status and notification icons. See “Viewing the Display Screen” for a list of icons you will see on the status bar.
2. **Application icon:** Tap to open the related application.
3. **All apps:** Tap to open the All apps screen. The All apps screen holds all applications on your device.
4. **Add to Home:** Tap to add shortcuts, widgets, and folders on the Home screen.
5. **Phone:** Tap to open the Phone screen to make calls.

Tip: While in any application, press  to go back to the Home screen.

Extended Home Screen

The Home screen extends beyond the screen width to provide more space for adding icons, widgets, and more. Press , and then slide your finger horizontally across the screen to go to the left or right side of the extended Home screen. There are six “additional” screens apart from the main Home screen.

Your Home screen may look like this:



Note: You cannot add more screens.

Tip: While on an extended Home screen, press  to return to the main Home screen.

To directly go to a particular Home screen:

1. On any Home screen, pinch the screen to bring up a snapshot of the Home screen.

Tip: On the main Home screen, you can press  to show the snapshot of the Home screen.

2. Tap the screen you want to open.

Customizing the Home Screen

To add a Home screen item:

1. Press  and tap .



Note: You can also press and hold an empty area on the Home screen.

2. In the **Add to Home** options menu, tap the item you want to add to the Home screen:
 - **Widget:** Add HTC or Android™ widgets to the Home screen such as a clock, calendar, mail, people, Footprints, and more.
 - **Program:** Add shortcuts to applications on your phone. To quickly add an application shortcut that is on the All apps screen to the Home screen, press and hold an application icon. When the device vibrates, drag the icon on an empty area on the Home screen, and then release it.
 - **Shortcut:** Add shortcuts to bookmarked Web page, a favorite contact, a Gmail™ label, a music playlist, and more.
 - **Folder:** Add a folder where you can organize Home screen items. Add a shortcut to all your contacts, contacts with phone numbers, or starred contacts. Contact details are automatically updated when there are changes in the source.

Customize your Home screen by adding application shortcuts and widgets. You can also use preset widgets from a Scene. To use a Scene, press  >  and tap **Scenes**.

Tip: You can also create and save your custom scene. (See “Creating and Saving a Custom Scene” for details.)

To add a widget:

1. Press  and tap .
2. In the **Add to Home** options menu, tap **Widget**.
3. Select a widget to add to the Home screen, and then select a layout to use, when available.

Note: Most HTC widgets offer various layouts and sizes to fit your needs.

4. Tap **Select**.

Note: You may need to slide to another screen or remove a widget on the Home screen first if there is no space to place the new widget.

To reposition a Home screen item:

1. Press and hold the item on the Home screen you want to reposition to activate Edit mode.

Note: When Edit mode is activated, the item expands and the device vibrates.

2. Without lifting your finger, drag the icon to the position you want on the screen, and then release it.

Note: To move an item from the Home screen to an extended Home screen, press and hold the item and then drag it to the left or right edge of the screen until the display shifts to the extended Home screen. Position the item on the screen, and then release it.

To remove a Home screen item:

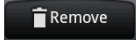

1. Press and hold the item on the screen you want to remove to activate Edit mode.

Note: When Edit mode is activated, the item expands and the device vibrates.

2. Drag the icon to the Phone button (The Phone button changes into )
3. When the icon and the Remove button turn red, release pressure.

To create a folder and add items to it:

You can create folders on the Home screen to hold application icons or shortcuts.

1. Press  >  and tap **Add to Home > Folder > New folder**. A new folder appears on the screen.
2. Press and hold an application icon or a shortcut on the Home screen to activate Edit mode, and then drag it on top of the folder.

To access the items inside a folder, tap the folder to open it and then tap the icon of the application or shortcut you want to open.

Note: To delete a folder, follow the same procedure as you would for removing a Home screen item.

To rename a folder:

1. Tap the folder to open it.
2. Press and hold the folder's title bar to open the **Rename folder** dialog box.
3. Enter the **Folder name** and then tap **OK**.

Creating and Saving a Custom Scene

Create your own custom scene and save it on your device.

1. Customize the Home screen by adding or removing widgets or application shortcuts, repositioning items, or changing the wallpaper.
2. After customizing, press  and tap **Scenes**.
3. On the Choose a scene options menu, select **Current (unsaved)** and tap **Save**.
4. Enter the **Scene name** and tap **Done**.

2B. Settings

- ◆ Personalization Settings (page 26)
- ◆ Sound Settings (page 27)
- ◆ Display Settings (page 29)
- ◆ Location Settings (page 30)
- ◆ Messaging Settings (page 31)
- ◆ Airplane Mode (page 32)
- ◆ TTY Use With Sprint Service (page 32)
- ◆ Security Settings (page 33)
- ◆ Data Synchronization Settings (page 34)
- ◆ Social Network Settings (page 35)
- ◆ Application Settings (page 36)
- ◆ Date & Time Settings (page 37)
- ◆ Locale & Text Settings (page 37)
- ◆ Power-Saving Tips (page 37)

Personalization Settings

Scenes

Selecting a Scene

Customize your device's Home screen appearance by selecting a scene to reflect your lifestyle. Scenes are preset Home screen layouts that you can quickly apply.

- ▶ Press  > , tap **Scenes**, and then tap a scene to apply it to the Home screen.



To save a custom scene:

- ▶ Customize the Home screen by changing the wallpaper and adding widgets, press , and then tap **Scenes > Current (unsaved) > Save**. Enter the **Scene name** and then tap **Done**.

Tip: You can rename or delete a custom scene in the Settings screen. On the Settings screen, tap **Personalize > Scenes**, and then press and hold a custom scene.

Renaming or Deleting a Scene

You can rename or delete a custom scene. To learn how to create a custom scene, see “Creating and Saving a Custom Scene” on page 25.

1. Press  >  and tap **Settings > Personalize > Scenes**.
2. Press and hold the custom scene (under **My scenes**) and tap **Rename** or **Delete**.
3. Tap **Rename**, enter the new **Scene name**, and then tap **Done**.
– or –
Tap **Delete > OK**.

Note: You cannot rename or delete a preset scene.

Home Screen Wallpaper

See “Changing the Display Screen” for details.

Default Ring Tone

See “Phone Ring Tone” for details.



Sound Settings

Phone Ring Tone

Select a default ring tone for incoming calls.

Selecting the Default Ring Tone

Your device provides a variety of ring tones that you can set as the default ring tone of your device.

1. Press  >  and tap **Settings > Sound & display > Phone ringtone**.
2. Tap the ring tone you want to use, and then tap **OK**. The ring tone briefly plays when selected.



Note: You can use *.wav, *.mid, *.mp3, *.wma, or other types of sound files that you downloaded from the Internet or copied from your computer as ring tones.

Notification Sound

Select a default sound for notifications.



Selecting the Default Notification Sound

Your device provides a variety of sounds that you can set as the default sound for notifications.

1. Press  >  and tap **Settings > Sound & display > Notification sound**.
2. Tap the sound you want to use, and then tap **OK**. The sound plays when selected.

Adjusting the Device's Volume Settings

Adjust your device's volume settings to suit your needs and your environment.

1. Press  >  and tap **Settings > Sound & display**.
2. Tap **Ringer volume** or **Media volume**.
3. Drag the volume slider on the screen to adjust the volume and then tap **OK**.

Note: You can adjust the ringer volume in standby mode (or the earpiece volume during a call) by using the volume buttons on the right side of your device.

Vibrate



To set your device to vibrate instead of making any sounds:

- ▶ Press the volume button down in standby mode until you see the image below on the screen.



The device vibrates and the vibrate mode icon () appears on the status bar.

To set your device to always vibrate in addition to any ringer settings:

1. Press  >  and tap **Settings > Sound & display**.
2. Select the **Phone vibrate** check box.
3. Press .

Silence All

The Silence All option allows you to mute all sounds without turning your device off.

To activate Silence All:

- ▶ Press the volume button down in standby mode until you see the image below on the screen.





The Silence All mode icon () appears on the status bar.

To deactivate Silence All:

- ▶ Press the volume button up repeatedly to select a volume level.



Alert Notification

Set your device to alert you with an audible tone when you are not within the Sprint coverage area or when you make an emergency call.

1. Press  >  and tap **Settings > Sound & display**.
2. Do any or all of the following:
 - Select the **Roaming ringtone** check box.
 - Tap **Emergency tone**, and then tap **Alert**.
3. Press .

Enabling Touch Tones



You can set the device to play a sound when you are using the phone keypad or tapping the screen.

1. Press  >  and tap **Settings > Sound & display**.
2. Do any or all of the following:
 - Select the **Audible selection** check box to set the device to play a sound every time you tap the screen.
 - Tap **Audible touch tones**, and then tap **Long tones** or **Short tones** to set the device to play a sound when you are using the phone keypad.
3. Press .

Display Settings

Changing the Screen Timeout Period

After a period of inactivity, the device screen turns off to conserve battery power. You can set the idle time before the screen turns off.



1. Press  >  and tap **Settings > Sound & display > Screen timeout**.
2. Tap the time before the screen turns off.

Note: Extended screen timeout periods reduce the battery's talk and standby times.

Tip: To turn off and lock the screen quickly, press the () key.

Changing the Display Screen

Changing the device's display screen wallpaper with preset wallpapers or your favorite photo is a quick and easy way to change the feel of your device and give it a fresh look. Browse the collection of wallpapers included in your device or choose from photos that you have taken with the camera. You can also change your Home screen to use an animated wallpaper.



1. Press  >  and tap **Wallpaper**.
2. Do one of the following:
 - Tap **HTC wallpapers** or **Android wallpapers** to use preset images.
 - Tap **Live wallpapers** to choose from preset animated wallpapers.
 - Tap **Gallery** to use a picture that you have captured using the camera or copied to your device as a wallpaper. You can crop the picture before setting it as a wallpaper.
3. Tap **Save** or **Set wallpaper**.

After changing the wallpaper, remember to save it to the scene that you created or save it as a new scene. For more information, see "Creating and Saving a Custom Scene."

Adjusting the Brightness



By default, the screen brightness automatically adjusts depending on the surrounding lighting conditions.

To manually adjust screen brightness

1. Press  >  and tap **Settings > Sound & display**.
2. Tap **Brightness** and then clear the **Automatic brightness** check box.
3. Drag the slider to adjust the brightness.
4. Tap **OK**.

Changing the Screen Orientation

By default, the screen orientation automatically changes when the device is rotated. To disable automatic screen orientation:



1. Press  >  and tap **Settings > Sound & display**.
2. Clear the **Orientation** check box and press .

Note: Not all application screens support automatic rotation.

The screen orientation automatically changes to landscape mode when you turn the device counterclockwise 90 degrees. If you turn the device clockwise 90 degrees, the screen orientation will not change to landscape mode.

Recalibrating the Screen

Recalibrate the screen if you feel that the screen orientation does not respond properly to the way you hold the device.

1. Press  >  and tap **Settings > Sound & display > G-Sensor calibration**.
2. Place the device on a flat surface and then tap **Calibrate**.
3. After the recalibration process, tap **OK**.



Location Settings

Your device is equipped with a Location feature for use in connection with location-based services.

The Location feature allows the network to detect your position. Turning Location off will hide your location from everyone except 911.

Note: Turning **Location** on will allow the network to detect your position using GPS technology, making some Sprint applications and services easier to use. Turning **Location** off will disable the GPS location function for all purposes except 911, but will not hide your general location based on the cell site serving your call. No application or service may use your location without your request or permission. GPS-enhanced 911 is not available in all areas.

To enable your device's Location setting feature:

1. Press  >  and tap **Settings > Location > Location setting**.
2. Read the Location disclaimer and then tap **ON**.
3. Press .

When you turn the Location setting feature on, the device displays the  icon on the status bar. When you turn Location setting off, the device displays the  icon.

Messaging Settings

Your device's advanced messaging capabilities let you send and receive many different kinds of text messages without placing a voice call. (For more information, see "Accessing Email Messages" on page 122.)

Messaging settings allow you to decide how you would like to be notified of new messages and create your own preset messages.

Setting Message Notification

When you receive a message, your device notifies you by displaying an icon on your display screen. You can also choose to vibrate the device and have the screen flash when you receive a message.

To display a notification and vibrate the device when you receive a message:

1. Press and tap > **Messages**.
2. Press and then tap **Settings**.
3. Scroll down the screen and select the **Play notification sound** and **Vibrate** check boxes.

Note: Tap **Notification sound** to choose a notification sound.

4. Press .

To flash the screen when you receive a message:

1. Press > and tap **Settings** > **Sound & display** > **Notification flash**.
2. Select the **SMS/MMS** check box and then press .

Managing Preset Messages

Your device is loaded with nine preset messages to help make sending text messages easier. Customize or delete these messages, such as "Where are you?," "Let's catch up soon," and "Just checking in" to suit your needs, or add your own messages to the list.

To edit or delete a preset message:

1. Press and tap > **Messages** > **New message**.
2. Tap the text box with the text "Tap to compose."
3. Press and tap **Quick text**. (You will see the list of preset messages.)
4. Press and:

Tap **Edit**, tap the message you want to edit, edit the message (see "Entering Text" on page 19), and then tap .

– or –

Tap **Delete**, select the message you want to delete, and tap **OK**. (Tap **Cancel** to cancel the deletion.)



To add a new preset message:

1. Press and tap > **Messages** > **New message**.
2. Tap the text box with the text "Tap to compose."
3. Press and tap **Quick text**. (You will see the list of preset messages.)
4. To add a new message, press and tap **Insert**.
5. Enter your message and tap . (Your new message will be added to the beginning of the list.)





Airplane Mode

Airplane Mode allows you to use many of your device's features, such as Gallery, camera, and Music, when you are on an airplane or in any other area where making or receiving calls or data is prohibited. When you set your device to Airplane Mode, it cannot send or receive any calls or access online information.

To quickly turn Airplane Mode on or off:

- ▶ Press and hold the power button (), and then tap **Airplane mode** in Phone options. While in Airplane Mode, the status bar will display .





To turn Airplane Mode on or off in Settings:

1. Press  >  and tap **Settings > Wireless & networks**.
2. Select the **Airplane mode** check box and press . While in Airplane Mode, the status bar will display .



TTY Use With Sprint Service

A TTY (teletypewriter, also known as a TDD or Text Telephone) is a telecommunications device that allows people who are deaf, hard of hearing, or who have speech or language disabilities, to communicate by telephone.

Your device is compatible with select TTY devices. Please check with the manufacturer of your TTY device to ensure that it supports digital wireless transmission. Your device and TTY device will connect using a special cable that plugs into your device's headset jack. If this cable was not provided with your TTY device, contact your TTY device manufacturer to purchase the connector cable.

When establishing your Sprint service, please call Sprint Customer Service using the state Telecommunications Relay Service (TRS) by first dialing    . Then provide the state TRS with this number: **866-727-4889**.

To turn TTY Mode on or off:

1. Press  >  and tap **Settings > Call > TTY mode**.
2. Tap **TTY Full**, **TTY HCO**, or **TTY VCO** to turn TTY mode on.
– or –
Tap **TTY Off** to turn TTY mode off.

Note: When enabled, TTY mode may impair the audio quality of non-TTY devices connected to the headset jack.

WARNING: 911 Emergency Calling



Sprint recommends that TTY users make emergency calls by other means, including Telecommunications Relay Services (TRS), analog cellular, and landline communications. Wireless TTY calls to 911 may be corrupted when received by public safety answering points (PSAPs), rendering some communications unintelligible. The problem encountered appears related to TTY equipment or software used by PSAPs. This matter has been brought to the attention of the FCC, and the wireless industry and the PSAP community are currently working to resolve this.

Security Settings

Protecting Your Device with a Screen Lock

You can increase the security of your device by creating a screen unlock pattern. When enabled, you have to draw the correct unlock pattern on the screen to unlock the device's control keys and buttons and touch screen.

To create and enable the screen unlock pattern:



1. Press  >  and tap **Settings > Security > Set unlock pattern**.
2. Read the information on the screen and tap **Next**.
3. Study the example pattern on the screen, and then tap **Next**.
4. Draw the screen unlock pattern by connecting at least four dots in a vertical, horizontal or diagonal direction. Lift your finger from the screen when finished.

Note: You must slide your finger on the screen to create the pattern and not tap individual dots.

5. The device records the pattern. Tap **Continue**.
6. When prompted, draw the screen unlock pattern again, and then tap **Confirm**.

Tip: Clear the **Use visible pattern** check box if you do not want the unlock pattern to display on the screen when you unlock it.

If you want to disable the unlock screen pattern, clear the **Require pattern** check box. You will be prompted to draw the unlock screen pattern.

Note: To change your unlock screen pattern, press  > , and then tap **Settings > Security > Change unlock pattern**.



When you fail to draw the correct unlock pattern on the screen after five attempts, you will be prompted to wait for 30 seconds before you can try again.

Updating Your Device's System Software

From time to time, system software updates for your device may be available. Your device can automatically check and then notify you if an update is available. You can then download and install the update to your device. Depending on the type of update, the update may erase all your personal data and customized settings, and also remove any programs you have installed. Make sure that you have backed up the information and files you want to keep.

Note: Checking and downloading system software updates may incur additional data transfer fees.

To check for phone system software updates manually

1. Press  >  and then tap **Settings > System updates > HTC software update**.
2. On the System software updates screen, tap **Check now**.

Resetting Your Device

Resetting the device deletes all data, including downloaded applications, and resets the device back to its initial state—the state before you turned on the device for the first time.

Important: Make sure to back up important data you have on the device before you reset it.

▶ Press  >  and tap **Settings > Privacy > Factory data reset > Reset phone**.

To reset the device using the device keys:



1. With the device turned off, press and hold the volume down button (located at the right panel of the device), and then press the power button.
2. When the device's display turns on, release the volume down button.
3. Use the volume buttons to select **CLEAR STORAGE**, and then press the power button. (All data will be deleted from the device.)

Security Features for Data Services

Enabling and Disabling Data Services

You can disable data services without turning off your device; however, you will not have access to all data services, including Web and messaging. Disabling data services will avoid any charges associated with these services. While signed out, you can still place or receive phone calls, check voicemail, and use other voice services. You may enable data services again at any time.

To enable or disable data services:

1. Press  >  and tap **Settings > Wireless & networks**.
2. Select the **Mobile network** check box to enable data services.
– or –
Clear the **Mobile network** check box to disable data services

Data Synchronization Settings

Synchronizing Google Apps

Your device's Google Apps™, such as Gmail, Calendar, and Contacts, give you access to the same personal information (emails, events, and contacts) that you add, view, and edit on your computer using Gmail or Calendar. Synchronize the Google Apps you want to keep information up-to-date.

Note: You need to be signed in to your Google account to synchronize Google Apps.

To select which Google Apps to synchronize:

1. Press  >  and then tap **Settings > Accounts & sync**.

Tip: Select the **Auto-sync** check box to automatically synchronize all applications. When the **Auto-sync** check box is cleared, you can synchronize individual applications manually by selecting their respective check boxes.

2. Tap **Google**.
3. Select the Google Apps you want to synchronize.

To stop synchronization:



- ▶ When the device is synchronizing, tap **Cancel sync** to stop synchronization.

Synchronizing Exchange ActiveSync



You can synchronize your device with your company's Microsoft Exchange Server to let you access your device's Exchange Server account's email, contacts, and calendar events.

Note: You need to have an Exchange ActiveSync account set up on your device. See "Email" on page 122.

To select which Exchange ActiveSync items to synchronize:

1. Press  >  and tap **Settings > Accounts & sync > Exchange ActiveSync**.
2. Select the Exchange ActiveSync items you want to synchronize.



To change the synchronization schedule:

1. Press  >  and tap **Settings > Accounts & sync > Exchange ActiveSync > Schedule**.
2. Tap the time interval the device will check for new data.

To manually start synchronization:

- ▶ On the Microsoft Exchange ActiveSync screen, tap **Sync now**.

To change account settings:

1. Press  >  and tap **Settings > Accounts & sync > Exchange ActiveSync > Account settings**.
2. Change the general settings, mail, and calendar settings according to your preference.
3. Press .



Social Network Settings

Logging in to and Synchronizing Your Social Network Accounts



If you have set up a Facebook for HTC Sense, Flickr, or Twitter account when you first turn on your device, you can quickly login and synchronize information such as status messages and friends list between your device and your social network accounts on the Web.

Note: You need to have an existing Facebook, Flickr, or Twitter account.



To log in to your Facebook or Twitter account:

1. Press  >  and tap **Settings > Accounts & sync**.
2. Tap **Facebook for HTC Sense** or **Twitter**.
3. Enter your username and password and then tap **Sign in**.



To log in to your Flickr account:

1. Press  >  and tap **Settings > Accounts & sync**.
2. Tap **Add account > Flickr**.
3. Enter your Yahoo! ID and password and tap **Sign in**.
4. Follow the screen instructions to log in to your Flickr account.

To synchronize your Facebook or Twitter account:

1. Press  >  and tap **Settings > Accounts & sync**.
2. Tap **Facebook for HTC Sense** or **Twitter**.
3. Tap **Sync now**.

To remove a social network account:

1. Press  >  and tap **Settings > Accounts & sync**.
2. Tap the account you want to remove.
3. Tap **Remove account**.



Tip: On the Social Networks screen, press  and tap **Log out all** to log out from all the social network accounts.

Application Settings

Allowing Third-Party Programs to be Installed



By default, you can only install programs and games downloaded from Android Market™.

To install third-party programs on the device:

- ▶ Press  > , tap **Settings > Applications**, and then select the **Unknown sources** check box.

To uninstall third-party programs on the device:

You cannot uninstall programs that are preinstalled on the device.

1. Press  >  and tap **Settings > Applications > Manage applications**.
2. On the Manage applications screen, tap the application you want to uninstall.
3. On the Application info screen, tap **Uninstall**.

Clearing Application Cache and Data

Free up storage space and device memory by deleting application cache and data.

1. Press  >  and tap **Settings > Applications > Manage applications**.
2. In the Manage applications list, tap the application whose cache or data you want to delete.



Tip: Press  to bring up sort and filter options.

3. In the Application info screen, tap **Clear data** or **Clear cache**.

Date & Time Settings

Setting Local Date, Time Zone, and Time

By default, your device automatically uses the network-provided date, time zone, and time. However, you can set the date, time zone, and time manually if you need to.

1. Press  >  and tap **Settings > Date & time**.
2. Clear the **Automatic** check box.
3. Tap **Set date**. On the Change date window, adjust the date by scrolling the date wheel. Tap **Done** when finished.
4. Tap **Select time zone**, and then select the time zone in the list. Scroll down the list to view more time zones.
5. Tap **Set time**. On the time window, adjust the time by scrolling the time wheel. Tap **Done** when finished.
6. Select the **Use 24-hour format** check box to toggle between using a 12-hour or 24-hour format.
7. Tap **Select date format**, and then select how you want dates to display on your device. The selected date format also applies to the date displayed in the Alarm Clock.







Locale & Text Settings

Setting Onscreen Keyboard Settings

8. Press  >  and tap **Settings > Language & keyboard > Touch Input**. (See “Adjusting Touch Input Settings” on page 21 for details.)



Power-Saving Tips

Adjusting the Display Brightness and Screen On-Time



- Press  > , tap **Settings > Sound & display > Brightness**, and then modify the backlight setting as desired. For more information, see “Display Settings.”
 - or –
- Add the **Power Control** widget to the home screen to easily adjust the screen brightness. Press  and then tap  > **Add to Home > Widget > Power Control**.
- Set a shorter time before the screen turns off when the device is idle. Press  > , tap **Settings > Sound & display > Screen timeout**, and then select a timeout value.
- To turn off the screen, press the power button. The device will continue to function.

Managing Your Device's Wireless Functions

Disable the 4G, Sprint Mobile Hotspot, Wi-Fi, Bluetooth, and GPS functions of the device when not in use.





- ▶ Press  > , and then tap **Settings > Wireless & networks**. Disable any wireless functions (for example, **Bluetooth** or **Wi-Fi**) that are not in use.

– or –

- ▶ Add a Bluetooth, GPS, and Wi-Fi widget to the home screen. Press  and then tap  > **Add to Home > Widget > Settings**.

Setting the Email Synchronization Schedule

If you use the device to send and receive email, you can set your email account to download email more or less frequently as desired.

1. Press  and tap  > **Mail**.
2. If you have set up multiple email accounts on your device, switch to the email account that you want to edit by tapping .
3. In the Inbox, press  and tap **More > Settings > Send & Receive > Schedule**.
4. In the **Frequency** section, tap **Peak times** or **Off-peak times**, and then select an email download frequency.

Note: The more frequently your device checks for new messages, the more quickly the battery will run down.

Tip: You can also close applications that are not in use to conserve battery power. To do so, you will need to download and install a third-party application called a **task manager** from the Android Market. For more information, see “Downloading Applications and Games From Android Market” on page 136.

2C. History

- ◆ Viewing History (page 39)
- ◆ Making a Call From History (page 39)
- ◆ Saving a Number From History (page 40)
- ◆ Prepending a Number From History (page 40)
- ◆ Erasing History (page 40)

Viewing History

History is a list of phone numbers (or People entries) for calls you placed, accepted, or missed. History makes redialing a number fast and easy. It is continually updated as your device automatically adds new numbers to the beginning of the list.

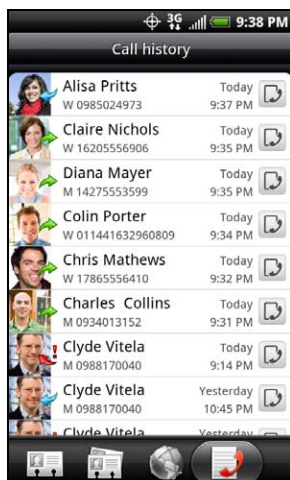

Each entry contains the phone number (if it is available) and People entry name (if the number is in People). Duplicate calls (same number and type of call) may only appear once on the list.

1. Press and tap > **People**.
2. Tap the Call history tab .
3. Tap at the right side of a number of contact to view the call history for that number or contact.

Note: History records only calls that occur while the device is turned on. If a call is received while your device is turned off, it will not be included in history.

Making a Call From History



1. Press and tap > **People**.
2. Tap the Call history tab .
3. Tap an entry on the Call history list to place a call to that entry.

Note: You cannot make calls from History to entries identified as **No ID** or **Restricted**.

Tip: Press and hold an entry in the Call history list to open the options menu where you can select to view the contact information (if number is stored in People), edit the number before you redial, send a text message, or delete the entry from the Call history list.

Saving a Number From History

If the phone number of a person who called is not in People, you can choose to save the number after you hang up.

1. Press  and tap  > **People**.
2. Tap the Call history tab .
3. Press and hold the received call and then tap **Save to contacts** on the options menu.
4. The phone number is automatically added to the **Mobile** box in the Number section. Enter the name and other contact information.

Tip: To store the number as another type (for example, home number), tap the **Mobile** button.





5. Scroll down the screen and tap **Save**.

After you have saved the number, your device displays the new People entry. (See “Displaying an Entry in People” on page 45.)

Note: You cannot save phone numbers already in People or from calls identified as **No ID** or **Restricted**.



Prepending a Number From History

If you need to make a call from History and you are outside your local area code, you can add the appropriate prefix by prepending the number.





1. Press  and tap  > **People**.
2. Tap the Call history tab .
3. Press and hold the entry you want to call and tap **Edit number before calling**.
4. Enter the prefix and tap  to call the number.

Erasing History

To erase a History entry:

1. Press  and tap  > **People**.
2. Tap the Call history tab .
3. Press and hold the entry you want to delete and tap **Delete from call history**.

To erase all History entries:

1. Press  and tap  > **People**.
2. Tap the Call history tab .
3. Press  and tap **Delete all**.

2D. People

- ◆ About People (page 41)
- ◆ Using the People Screen (page 42)
- ◆ Adding a New People Entry (page 43)
- ◆ Saving a Phone Number (page 44)
- ◆ Using the Contact Details Screen (page 44)
- ◆ Merging Entries in People (page 45)
- ◆ Editing an Entry in People (page 45)
- ◆ Finding Entries in People (page 47)
- ◆ Backing Up and Importing Entries in People (page 48)
- ◆ Working with Groups (page 48)
- ◆ Using the People Widget (page 49)
- ◆ Connecting with Your Social Networks (page 50)
- ◆ Using Friend Stream (page 52)

About People

In People, you can easily manage your communications with contacts through phone, messaging, and email. You can also view updates on their Facebook, Flickr, and Twitter accounts.



If you are synchronizing contacts with your Google account, with your PC, or with an Exchange Server, any contacts stored in those accounts are displayed in People. You can also synchronize contacts from your Facebook account in People.

Ways of Getting Contacts Into Your Device

You can add contacts to your device from:

- **Gmail contacts** that are imported to your device after you set up a Google Account. (For more information, see “Gmail” on page 126 for details.)
- **Phone contacts** (For more information, see “Adding a New People Entry” for details.)
- **Exchange ActiveSync Server** (For more information, see “Email” on page 122 for details.)
- **Contacts on your computer** (For more information, see “HTC Sync” on page 65 for details.)
- **Facebook** (For more information, see “Your Contacts List” for details.)

To open People:

- ▶ Press  and tap  > **People**. (You may need to scroll down the screen to see the icon.)

Using the People Screen

The People screen gives you easy access to all your contacts, as well as even faster access to the people and groups of people you contact most often.

The People screen has the following tabs:



1. **All** gives you access to all contacts on your device, including Google contacts, Exchange ActiveSync contacts, Phone contacts, and Facebook contacts. You can also use this tab to open or update My contact card. For more information, see “Setting Up My Contact Card” in this chapter.
2. **Groups** lets you assign contacts to groups so you can easily send an SMS, MMS, or email message to a whole group. (For more information, see “Working with Groups” for details.)
3. **Online directories** lets you search for contacts on your online directories such as your Exchange ActiveSync or Facebook account to copy to your device. (For more information, see “Connecting with Your Social Networks.”)
4. **Call history** lists all your dialed numbers and received and missed calls. (See “History” on page 39 for details.)

Setting Up My Contact Card

My contact card provides a convenient way to store your personal contact information so that you can easily send it using MMS, email, or Bluetooth.

To set up My contact card:

1. On the **All** tab of the People screen, tap **Me**.

Tip: If you are logged in to your Facebook account through Facebook for HTC Sense, instead of **Me**, you will see the name you use in Facebook.

2. Enter your name and contact details.
3. Tap **Save**.

Your Contacts List

The **All** tab of the People screen shows all your contacts, including Google contacts, Exchange ActiveSync contacts, Phone contacts, and Facebook contacts.

Note: If you signed in to your Google Account and Facebook account when you first set up the device, your contacts from those accounts will appear in the contacts list when you open People.



1. Add a contact.
2. Edit or update My Contact Card.
3. Tap a contact to open the contact details for that contact.
4. The green icon () appears when the contact:
 - Has sent you a new text or email message, or tried to call you but you missed the call.
 - Has updated his or her Facebook profile or has added photos on Flickr or Facebook.
 - Has upcoming Facebook events.
5. The Facebook status appears when you link the contact to their Facebook account.
6. Tap the photo or icon to open a menu where you can quickly choose how to communicate with the contact. Depending on the contact information stored, you can call, send a message or email, see the contact's Facebook profile, and locate the contact's address in Google Maps.

Adding a New People Entry

1. On the **All** tab, tap **Add contact** at the top of the screen.

Note: If you have set up a Google Account or an Exchange ActiveSync email account, the **Contact type** option appears to determine which account the contact will sync with.

2. Tap the **Name** box, enter the first and last name of the contact, and choose the order in which to display the names. Tap **OK**.
3. Enter the contact information in the boxes provided.
4. Scroll to the bottom of the screen and tap **Save**.

After saving the number, your device displays the new entry in the contacts list.

Saving a Phone Number

To save a number from standby mode:

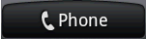
1. Press  and tap .
2. Enter the phone number by tapping the keys on the keypad.
3. Tap **Save to People**. (This button appears after tapping six digits.)
4. Tap **Add contact** or **Save to existing contact**.
5. Use the keyboard to enter the new contact name and tap **Save** to save the new entry.
– or –
Tap an existing contact name and tap **Save** to save the new number.

Using the Contact Details Screen

When you tap a contact on the People screen, the Contact Details screen opens, showing you the information stored for that contact, exchanged messages and phone calls with that contact, Facebook notifications, and more.

The Contact Details screen has the following tabs:







1. **Details** shows the information you have stored for the contact, and allows you to get in touch with the contact directly by tapping any of the displayed methods. For example, if the contact has a stored work phone number, tap **Call Work** to call that number. You can also add one of the contact's phone numbers as a speed dial number. For more information, see "Speed Dialing" on page 19.
2. **Messages** shows your exchanged SMS messages with the contact. Tap a message to view it. To send a new message, tap **New message**. For more information about messages, see "Text Messaging (SMS) and Multimedia Messaging (MMS)" on page 102.
3. **Mail** shows email messages you have received from the contact. Tap an email message to view it. To send a new email, tap **New mail**. For more information about email, see "Email" on page 122.
4. **Updates and events** shows the contact's Facebook status, updates, and events, and shows when he or she uploads new photos to Flickr. When there is a notification of the contact's birthday, you can tap the notification to call the contact directly or send a message greeting.
5. **Gallery** shows the contact's Facebook and Flickr photo albums. For more information, see "Viewing Photos in Your Social Networks."
6. **Call history** lists all your incoming, outgoing, and missed calls to and from the contact. Tap a list item to call the contact using the displayed number.

Merging Entries in People





Merge duplicated entries in People to avoid clutter and confusion. If you have the same contact appear in your Phone, Google, and Facebook accounts, you can merge the contact information into one entry.

The device automatically merges entries that it finds to have similar data. If you need to manually merge entries or break the link between entries, follow the procedures below.

Manually Merging Entries in People

1. Press  and tap  > **People**.
2. On the **All** tab, tap the entry (not the icon or photo) you want to merge with another entry on your device.
3. On the upper right corner of the screen, tap  or  (if there are suggested links.)
4. On the screen, you can:
 - If there are suggested links, tap  to link the entry to the selected account.
 - Tap one of the options available in the Add contact section.
5. Tap **Done**.

Breaking the Contact Information Link Between Entries

1. Press  and tap  > **People**.
2. On the **All** tab, tap the entry (not the icon or photo) whose contact information link you want to break.
3. On the upper right corner of the screen, tap .
4. On the Linked contacts section, tap  beside the entry to break the link.
5. Tap **Done**.

Editing an Entry in People

Displaying an Entry in People

- Press  and tap  > **People**, and then tap an entry.

Adding a Number to an Entry in People

1. Display an entry in People. (See “Displaying an Entry in People” for details.)
2. Scroll down the screen and tap **Edit**.
3. Scroll down the screen and tap **Add > Phone**.
4. Tap the type of phone number you want to add. (For example, **Home** or **Work**.)
5. Enter the phone number and tap **Save**. (Scroll down the screen to see the **Save** button.)

Editing an Entry in People

1. Display an entry in People. (See “Displaying an Entry in People” for details.)
2. Scroll down the screen and tap **Edit**.
3. Under the **Phone** section, tap the number you want to edit.
4. Edit the number using the keypad.

Tip: Tap the Number type (for example, ) to change the type of number.

Tap **X** at the right side of a number to delete it.

5. Tap **Save**. (Scroll down the screen to see the **Save** button.)

Selecting a Ringer Type for an Entry

Assign a ringer type to an entry in People so you can identify the caller by the ringer type. (See “Sound Settings” on page 27.)

1. Display an entry in People. (See “Displaying an Entry in People” for details.)
2. Scroll down the screen, and then tap **Ringtone**.
3. Select a ring tone (the ring tone plays back) from the menu and tap **OK**.

Assigning a Picture to an Entry

Assign a picture to display each time a certain contact calls you.

1. Display an entry in People. (See “Displaying an Entry in People” for details.)
2. Scroll down the screen and tap **Edit**.
3. Tap  at the top-left corner of the screen.
4. Tap **Gallery** or **Camera**.
 - If you selected **Gallery**, select an album to find the picture, tap the picture you want to use, crop the picture, and tap **Save**.
 - If you selected **Camera**, the camera will launch and you will use it to take a new picture. (See “Camera and Multimedia” on page 75.)
5. Tap **Save**. (Scroll down the screen to see the **Save** button.)

Adding an Email Address to an Entry



1. Display an entry in People. (See “Displaying an Entry in People” for details.)
2. Scroll down the screen and tap **Edit**.
3. Under the **Email** section, tap the box after .
4. Enter the email address and tap **Save**. (Scroll down the screen to see the **Save** button.)

Adding Additional Information to an Entry

You can add additional information to an entry in People.

1. Display an entry in People. (See “Displaying an Entry in People” for details.)
2. Scroll down the screen and tap **Edit**.
3. Scroll down the screen and tap **Add**.
4. Tap the type of information you want to add such as **Phone**, **Email**, or **Postal address**.



Sending an Entry as a vCard Using MMS

1. Press  and tap  > **People**.
2. On the **All** tab, press and hold the name of the contact (not the icon or photo) whose contact information you want to send, and then tap **Send contact as vCard**.
3. Select the type of information you want to send, and then tap **Send**.
4. Enter the recipient's number or email address, and then tap **Send**.



Note: You cannot send a vCard using SMS.

You can also send the vCard using Bluetooth. To learn how to send files through Bluetooth, see “Bluetooth” on page 94.

Deleting an Entry



1. Press  and tap  > **People**.
2. Tap a contact you wish to delete.
3. Press  and then tap **Delete**.
4. Tap **OK** to confirm the deletion.

Deleting Multiple Entries



1. Press  and tap  > **People**.
2. On the **All** tab, press , and then tap **Delete**.
3. Select the entries you want to delete, and then tap **Delete**.
4. Tap **OK** to confirm the deletions.

Finding Entries in People

Finding Contacts by Name

1. Press  and tap  > **People**.
2. Scroll through all the entries.
– or –
Press  and enter the first letter or letters of a name (such as “dav” for “Dave”). (The more letters you enter, the more your search narrows.)
3. To display an entry, tap an entry.
4. To dial the entry's default phone number (Primary), tap the number under **Action**.

Finding Group Entries

1. Press  and tap  > **People**.
2. Scroll to the **Groups** tab.
3. Scroll through the group titles. To display entries belonging to a group, tap the group name.
4. To display an entry within the group, tap the entry.
5. To dial the entry's default phone number (Primary), tap the number under **Action**.

See “Working with Groups” for more details.



Backing Up and Importing Entries in People

Backing Up People Entries to the Storage Card

1. Press  and tap  > **People**.
2. Press  **menu**, and then tap **Import/Export** > **Export to SD card**.
3. When asked to confirm, tap **OK**.

Importing Entries From the Storage Card

You can only import contacts that were exported to the storage card using the Export to SD card feature on the device. See “Backing Up People Entries to the Storage Card”.



1. Press  and tap  > **People**.
2. Press  **menu**, and then tap **Import/Export** > **Import from SD card**.
3. If you have Google or Exchange ActiveSync accounts set up on your device, tap the type for the imported contacts.

Tip: Press  to stop importing contacts from the storage card.





Working with Groups

On the **Groups** tab, you can assign contacts to groups so you can easily send SMS, MMS, or email messages to a whole group. You can also sync your device's groups with the groups in your Google account, accessible using your computer's Web browser.



Creating a Group and Adding Entries

1. Press  and tap  > **People** > **Groups** tab > **Add group**.
2. Enter a name for the group and tap **Add contact to group**.
3. Select the entries you want in the group. You can use the search bar to search for entries quickly.
4. Tap **Save**.

Adding or Removing Entries From a Group

1. Press  and tap  > **People** > **Groups** tab.
2. Press and hold a group and tap **Edit group**.
3. To add entries to the group, tap **Add contact to group**, tap the entries you want to add, and tap **Done**.
– or –
To remove entries from the group, tap  at the right side of the entry you want to remove.
4. Tap **Save**. (Tap  to close the keyboard if you do not see the **Save** button.)



Sending a Text or Multimedia Message to All Entries in a Group

1. Press  and tap  > **People** > **Groups** tab.
2. Tap the group you want to send a message to.
3. Go to the **Group action** tab, and then tap **Send group message** to send a message to the group.

Note: You will be charged per group member for each message sent. For example, if you send a message to a group of five people, you will be charged for five messages.

For instructions on composing and sending your message, see “Composing Text Messages” on page 102.

Sending an Email Message to All Entries In a Group

1. Press  and tap  > **People** > **Groups** tab.
2. Tap the group you want to send an email to.
3. Go to the **Group action** tab, and then tap **Send group mail** to send an email to the group.
4. Tap **Compose** to use Gmail to send the email message. (You need to be signed in to your Google account to use Gmail.)
 - or –
 - Tap **Mail** to use your Exchange ActiveSync or POP3/IMAP email account to send the email message. (You need to have an email account set up on your device.)

For instructions on composing and sending your message, see “Composing and Sending Email” on page 123.



Deleting a Group

1. Press  and tap  > **People** > **Groups** tab.
2. Press and hold a group and tap **Delete group**.

Using the People Widget

Put the group of people you contact most right on the Home screen of your device by adding them as the People widget. Using the People widget, you can instantly place a call, send a message, or view details of a favorite contact with a single tap.

Adding the People Widget

1. Press  and tap  > **Widget** > **People**.
2. Choose the widget style, and then tap **Select**.
3. Select the group you want to add as a widget.
4. Drag the widget to a blank Home screen, and then release.

Tip: The People widget requires a whole screen.

Setting the Default Communication Method

1. Press , and then go to the People widget.
2. Tap a contact on the widget.
3. On the Select default action screen, tap the communication method you want for the contact.

Changing the Default Communication Method

If you want to change the default action for communicating with a contact on the People widget, you must first remove this contact from the group. Add this contact back to the group, and then choose the new communication method.

1. Remove the contact from the group. See “Adding or Removing Entries From a Group” on page 48 for details.
2. Add the contact back to the group. See “Adding or Removing Entries From a Group” on page 48 for details.
3. Choose the default communication method See “Setting the Default Communication Method” for details.

Getting In Touch with a Contact

1. Press , and then go to the People widget.
2. Do any of the following:
 - Tap a contact’s icon or photo on the widget. The default communication method will be performed. If you have not set a default communication method, the Select default action screen will open. See “Setting the Default Communication Method” for details.
 - Tap the name of the contact to open the contact details screen. On the contact details screen, choose how you want to communicate with the contact by tapping an option under Action.

Connecting with Your Social Networks

Facebook for HTC Sense

View your Facebook® updates in supported applications on the device. See “Logging in to and Synchronizing Your Social Network Accounts” on page 35 to learn how to sign in to Facebook for HTC Sense.

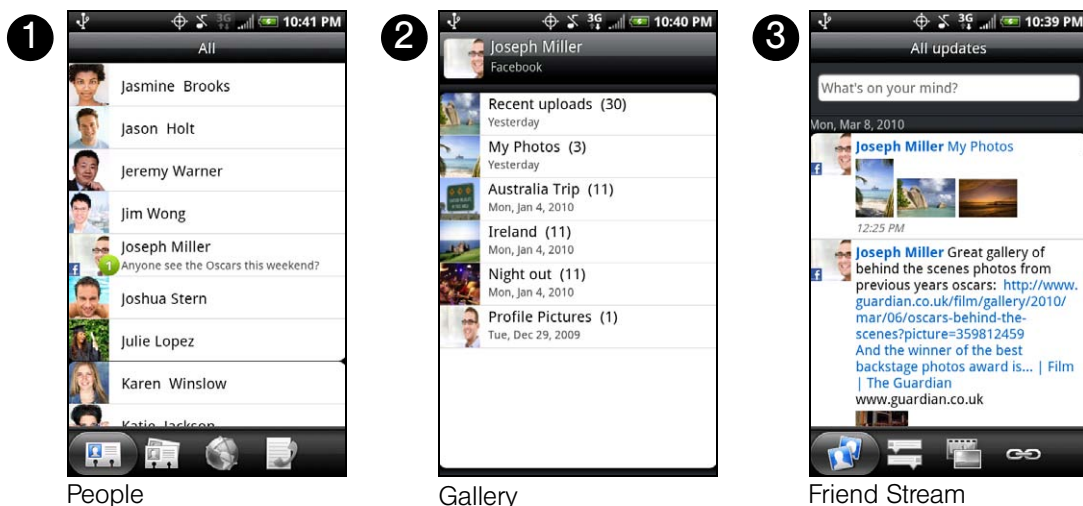

After signing in to Facebook for HTC Sense, you can:



1. Download your Facebook contacts and their contact details to People on your device. Your Facebook contacts’ status updates display on your contacts list.
2. Browse through Facebook photo albums in Gallery. For more information, see “Viewing Photos in Your Social Networks” on page 83

3. Read Facebook status updates in Friend Stream. For more information, see “Using Friend Stream”.



Updating Your Facebook Status

1. Press  and tap  > **People** > **All** tab.
2. Tap **Me** or **[Your Name]** > **Facebook**.
3. Enter your status in the “What’s on your mind” text box and tap **Share**.

Synchronizing Facebook for HTC Sense

See “Social Network Settings” on page 35.

Changing Facebook for HTC Sense Update Settings



1. Press  >  and tap **Settings** > **Accounts & sync**.
2. Tap **Facebook for HTC Sense**.
3. Tap **Account settings** > **Update schedule**, and then select the time interval.

Facebook for Android

The Facebook® application on your phone lets you keep up and stay close with your friends in Facebook. It offers most of the features that you are familiar with when using Facebook on your computer.

If you have more than one Facebook account, you can sign in to the Facebook application using your other Facebook account.

Opening Facebook

1. Press  and then tap  > **Facebook**.
2. If this is your first time to use Facebook, follow the onscreen instructions to sign into your Facebook account. Your Facebook profile is then displayed on the screen.
3. Press  to go to the Facebook home screen and access other functions.

Note: While on the Facebook home screen, press , and then tap **Settings** to set refresh and notification options.



On some Facebook screens, you can press and hold an item to open an options menu.

With the Facebook application, you can:

- Share your thoughts and check other people’s status updates.
- View your friends list and write on someone’s wall.
- Comment on and like a friend’s post.
- View someone’s personal information, including photo albums.
- Check your Facebook notifications.
- Take a photo and upload it straight to your Facebook account.

Adding the Facebook Widget

Add the Facebook widget to the Home screen to let you quickly share your thoughts and view your friends’ status updates.

1. Press  and then tap  > **Widget** > **Facebook**.
2. Choose the widget style, and then tap **Select**.
3. Drag the widget to a blank space on the Home screen, and then release.

Facebook FAQ



What are the differences Between Facebook for HTC Sense and Facebook for Android Application?

- Facebook for HTC Sense is not a standalone application. It is integrated into People, Friend Stream, and Gallery to give you up-to-date information about your Facebook contacts (their status updates and new photos) in these applications.
- The Facebook for Android application is a standalone application. Use this application to do most of the things that you would do when you're using your computer's Web browser to access your Facebook account, such as adding a friend and adding captions to photos you upload.
- The two do not share the same login credentials. Signing in to Facebook for HTC Sense does not sign you in to the Facebook application and vice versa. If you want to use the same Facebook account for both, you'll have to sign in to both using the same login credentials.

Using Friend Stream

Streamline your social network accounts through Friend Stream. Update your status simultaneously, view status updates, and look through photo updates from your Facebook, Twitter, and other social network accounts using Friend Stream.

Opening Friend Stream

1. Press  and then tap  > **Friend Stream**.
2. If you are not signed in to a social network account, you will be asked to sign in to at least one of the social network accounts.
3. Friend Stream opens in the All updates tab. Slide your finger on the bottom row to go to the tab you want.

The Friend Stream Screen



Only updates from accounts that you are signed in to will be shown. You can filter the updates that show in Friend Stream by pressing , and then tapping **Settings > Show updates**.



1. Tap to enter and send a status update.
2. Depending on the type, tap to open Peep, post a Facebook comment, look at the Flickr album, or open the link in the Web browser.
3. Shows all the messages from the social network accounts that you are signed in to.
4. Shows only links posted on Facebook.

5. Shows only photo updates from Facebook and Flickr.
6. Shows only status updates from Facebook and Twitter.

Updating Your Status

1. Press  and then tap  > **Friend Stream**.
2. On the All Updates tab, tap the text field with the words “What’s on your mind?”.
3. Tap , and then on the Update dialog box, select which accounts you want the status update to be posted. Tap **Done**.

Note: Only the accounts that you are signed in to will be shown on the dialog box.

4. Enter your status update, and then tap **Share**.

Adding the Friend Stream Widget

Add the Friend Stream widget so you can update your status simultaneously and view status updates from your social network accounts right on the Home screen.

1. Press  and tap  > **Widget** > **Friend Stream**.
2. Choose the widget style, and then tap **Select**.
3. Drag the widget to a blank space on the Home screen, and then release.

2E. Calendar and Tools

- ◆ Calendar (page 54)
- ◆ Calculator (page 59)
- ◆ Clock (page 59)
- ◆ Quickoffice (page 63)
- ◆ PDF Viewer (page 64)
- ◆ HTC Sync (page 65)
- ◆ Updating Your Device (page 68)

Calendar

Use Calendar to create and manage events, meetings, and appointments. Your Calendar helps organize your time and reminds you of important events. Depending on your synchronization settings, your device's Calendar stays in sync with your Calendar on the Web, Exchange ActiveSync calendar, and Outlook calendar.

Adding an Event to the Calendar

1. Press  and tap  > **Calendar**.
2. On any Calendar view, press  and tap **New event** to open the Event details screen.

Note: If you are in Agenda or Month view, you can also tap  at the bottom-right of the screen.

If you are in Day view, tap **Add event**.

3. If you have more than one calendar, select a calendar in which to add the event:
 - Select **My Calendar** to create an event that will appear only on your device.
 - Select your Google Account to create a Google Calendar event. If you have several Google Calendars on the Web, select one in which to add your event.

Note: You can create multiple Google Calendars only in Google Calendar on the Web. After creating them in Google Calendar on the Web, you'll be able to see them in the Calendar application on your device. For more information about creating and managing multiple Google Calendars, visit the Google website at the following URL:
<http://calendar.google.com>.

If you have synchronized your device with an Exchange ActiveSync account or Outlook on your computer, you can also select these calendars.

- Select **PC Sync** to create an Outlook Calendar event to sync with your computer.
 - Select **Exchange** to create an Exchange ActiveSync calendar event.
4. Enter a name for the event.
 5. To specify the date and time of the event, do one of the following:
 - If there is a time frame for the event, tap the **From** and **To** dates and times to set them.
 - If the event is a special occasion such as a birthday or an all-day event, set the **From** and **To** dates, and then select the **All Day** check box.
 6. Enter the event location and description.

7. Set the event reminder time.

Note: You can add another reminder time in a Google Calendar event. Press  and then tap **Add reminder** to add another reminder.

8. If the event occurs on a regular basis, tap the **Repetition** box and then choose how often the event occurs.
9. Scroll to the bottom of the screen and then tap **Save**.

Inviting Guests to Your Event (Google Account Only)



If you want to invite guests to your event, you need to create and add the event in your Google Calendar. An invitation email will be sent to your guests using your Google Account.

1. Open Calendar and create a new event. Tap the **Calendar** field and then select your Google Account (or one of your other Google Calendars). For the steps, see “Adding an Event to the Calendar.”
2. Add details about the event, such as date and time, location, and more.
3. In the **Guests** field, enter the email addresses of everyone you want to invite to the event. Separate multiple addresses with commas (,).
4. Tap **Save** to add the event to your Google Calendar.

If the people to whom you send invitations use Google Calendar, they’ll receive an invitation in Calendar and by email.

Sending a Meeting Request (Exchange ActiveSync only)

If you have an Exchange ActiveSync account set up on your device, you can use Calendar to create a meeting appointment and send a meeting request email to the people you want to invite to your meeting.

1. Open Calendar and create a new event. Tap the **Calendar** field and then select **Exchange**. For the steps, see “Adding an Event to the Calendar.”
2. Add details about the meeting, such as date and time, location, and more.
3. Press  and then tap **Meeting Invitation**.
4. Tap  and choose attendees from your contacts or Company Directory.
5. Enter the email subject and your message, and then tap **Send**.
6. Tap **Save** to add the meeting appointment to your Exchange ActiveSync Calendar.

Event Alerts

When your device is turned on and you have an event alarm scheduled, your device alerts you and displays the event summary. There are several ways your device alerts you to scheduled events:

- By playing the assigned ringer type.
- By showing the  icon on the status bar.
- By showing the Alert screen.

Event Reminders

If you have set at least one reminder for an event, the upcoming event icon () will appear in the notifications area of the status bar to remind you of the upcoming event.

To view, dismiss, or snooze the reminder:

1. Press the status bar, and then slide your finger down the screen to open the Notifications panel.
2. Tap the upcoming event name to display the event.

Note: If you have other pending event reminders, these events will also appear on the screen.

3. Do one of the following:

- Tap **Snooze all** to snooze all event reminders for five minutes.
- or –
- Tap **Dismiss all** to dismiss all event reminders.
- or –
- Press  to keep the reminders pending in the notifications area of the status bar.

To set reminder settings:

- ▶ On any Calendar view, press  and tap **More > Settings > Reminder settings**.

Viewing Events

You can display the Calendar in daily, weekly, monthly, or agenda view. To change the Calendar view, press  and tap **Day, Agenda, Week, or Month**.

Day and Agenda Views

Day view displays a list of the events of one day and also shows weather information at the bottom of the screen when you're viewing events of the current day. Agenda view shows a list of all your events in chronological order.

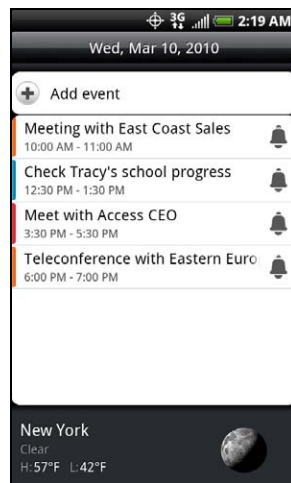

Day view

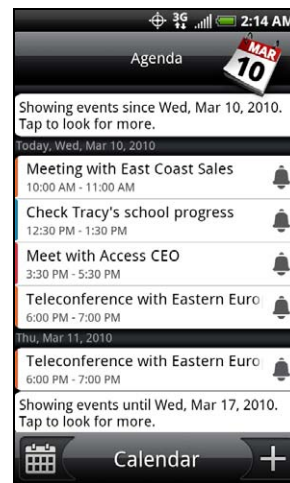

Agenda view

The color bars on the left side of the events indicate the type of calendar in which the event is part of. To find out what each color represents, press  and then tap **More > Calendars**.

When in **Day** view, slide left or right across the screen to view earlier or later days.

Note: In Day view, the weather information appears only if the event is within the five-day forecast of the Weather application.

Weather information does not appear in Day view when you change Day view to display as a time list. To check, in any calendar view, press , and tap **More > Settings > Calendar view setting > Day views**.

Week View

Week view displays a chart of the events of one week.

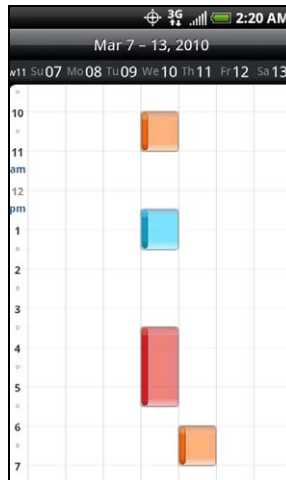

When in **Week** view:



- You can press and hold on a time slot to create a new event at that time.
- Tap an event to view its details.
- Slide left or right across the screen to view earlier or later weeks. Swipe your finger left or right to go to the earlier or later week.

Month View

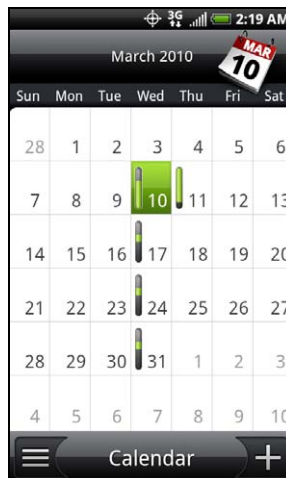

In Month view, you'll see markers on days that have events.



When in **Month** view:

- Tap  on the bottom left of the screen to switch to **Agenda** view. Tap  on the bottom right to create a new event.
- Tap a day to view the events of that day.
- Press and hold a day to open an options menu from which you can also choose to create an event or switch to either **Day** or **Agenda** view.
- Slide your finger up or down the screen to view earlier or later months.

Erasing Events

1. Press  and tap  > **Calendar**.
2. Open the calendar event details by:
 - In **Agenda, Day, and Week** views, tap the calendar event you want to delete.
 - In **Month** view, tap the date where the calendar event occurs, and tap the calendar event.
3. Press  and tap **Delete event**.
4. In the Delete confirmation box, tap **OK**.
 - or –
 - If the calendar event is recurring, select **Only this event** or **All events**, and tap **OK**.

Showing or Hiding Calendars



In any Calendar view, press , tap **More > Calendars**, and then select or clear a calendar to show or hide it. Tap **All calendars** to display all calendars.

The calendars are kept synchronized on your device, whether or not you hide them.

Choosing Google Calendars to Synchronized with Your Device

You can choose which Google Calendars to keep synchronized on your phone or which ones to stop synchronizing.



Stop Synchronizing a Google Calendar

1. In any Calendar view, press  and tap **More > Calendars**.
2. Press  and tap **Remove calendars**.
3. Select a Google Calendar to remove from your calendars list, and then tap **OK**.
4. Press  to update Calendar with the new changes and return to the Calendar view you were viewing.

The calendars that you remove from your calendars list will no longer be synchronized on your device, but you remain subscribed to them and can work with them in Google Calendar on the Web.

Adding a Google Calendar to Synchronize

Only the calendars that you've created or subscribed to on the Web, but previously removed from your calendars list, are shown in the list of calendars that you can add.

1. In any Calendar view, press  and tap **More > Calendars**.
2. Press  and tap **Add calendars**.
3. Select a Google Calendar to add to your calendars list, and then tap **OK**.
4. Press  to update Calendar with the new changes and return to the Calendar view you were viewing.

Synchronizing Exchange ActiveSync Calendar

If you have set up a Microsoft Exchange ActiveSync account on your device, you can also synchronize Exchange ActiveSync calendar events on your device. Calendar events on your Exchange ActiveSync will also show in Calendar if you chose to synchronize with the Exchange ActiveSync Server.



- To check if Exchange ActiveSync items are set to be synchronized, go to the Home screen, press , and tap **Settings > Accounts & sync > Exchange ActiveSync**.

Synchronizing Outlook Calendar

See “HTC Sync” on page 65 for details.

Sending a vCalendar

You can send a calendar event as a vCalendar to someone’s phone or your computer using Bluetooth. You can also send it as a file attachment with your message.

1. Press  and tap  > **Calendar**.
2. Press and hold the calendar event you want to send, and then tap **Share vCalendar**. In Month view, you need to tap the day when the event takes place before you can press and hold the event.
3. Choose whether to send the event using Bluetooth, Mail (email), or Message (Multimedia message or MMS).
4. Do one of the following:
 - If you chose to send using Bluetooth, in the next few steps, you’ll be asked to turn on Bluetooth on your device and connect to the receiving Bluetooth device so the vCalendar can be sent. For more information, see “Using Bluetooth” on page 94.
 - If you chose to send by email, a new message window opens and automatically includes the vCalendar as an attachment. Your default email account that’s selected in the Mail application will be used to send. For more information, see “Composing and Sending Email” on page 123.
 - If you chose to send by multimedia messaging (MMS), a new multimedia message window opens and automatically includes the vCalendar as an attachment. Enter your message recipients, compose your MMS message, and then tap **Send**. For more information, see “Sending a Multimedia Message (MMS)” on page 103.

Calculator

Your device comes with a built-in calculator.

1. Press  and tap  > **Calculator**.
2. Enter numbers or formulas using the onscreen keys.

Tip: To switch to a scientific calculator, turn your device sideways to your left. The scientific calculator lets you perform more complex calculations with square roots, logarithmic, and trigonometric functions.

Tap  to remove one digit at a time. Press and hold  to delete the entire number.

3. Tap  for the result.

Clock

The Clock application is more than just a regular date and time clock. It functions as a desk clock that shows the date, time, and weather information, and it can turn into a night clock or screensaver. It has a world clock that shows you the current time in several locations across the globe. There’s also an alarm clock, stopwatch, and countdown timer.

To open the Clock application:

- ▶ Press  and tap  > **Clock**.

Tap the tabs at the bottom row or slide your finger across the tabs to switch between the different functions of the Clock application.



1. **Desk Clock** For more information, see “Clock.”
2. **World Clock** For more information, see “World Clock.”
3. **Alarms** For more information, see “Alarm Clock.”
4. **Stopwatch** lets you use the clock as a stopwatch.
5. **Timer** lets you use the clock as a timer.

Desk Clock

Opening the Clock application brings you directly to the Desk Clock screen.

The Desk Clock displays the current date, time, and weather, an alarm clock indicator, and a battery charging indicator. You can dim the screen to show only the time and date on the Desk Clock.



1. **Weather information of your current location.** Tap the weather information to open the Weather application where you can see weather forecasts of the next few days. For more information, see “Weather” on page 141.
2. **Dim button** dims the screen and displays only the time and date on the Desk Clock. To light up the screen again, tap anywhere on the screen or press (⏪).
3. **Alarm clock indicator** shows whether the alarm clock is on or off. To find out how to turn on and set the alarm clock, see “Alarm Clock.”
4. **Screensaver button** dims the screen and go into screensaver mode. When in screensaver mode, the time and date will change position on the screen after every few minutes. To light up the screen again, tap anywhere on the screen or press (⏪).
5. **Battery charging indicator** shows the battery charge level. You’ll see it only when your device is plugged with the power adapter or connected to your computer.

You can change the Desk Clock screen to display the date and time of another time zone. For more information, see “World Clock.”



World Clock

Use the Clock application's World Clock screen to check the current time in several places around the globe simultaneously. You can also set your home city, add more cities to the world clock list, and manually set your time zone, date, and time.



To view the time in different locations:

- ▶ Press  and tap  > **Clock** > **World Clock** tab.



To add cities to the World Clock list:

1. Press  and tap  > **Clock** > **World Clock** tab > **Add city**.
2. Enter the city name you want to add. A list of matching cities and countries based on the letters you entered appear on the screen.
3. Tap the city.

To designate your home city:



1. Press , tap  > **Clock** > **World Clock** tab, and then press  > **Home settings**.
2. Enter your home city name. A list of matching cities and countries based on the letters you entered appear on the screen.
3. Tap your city when it appears on the list. Your home city will appear at the top of the list of cities.

To delete a city on the World Clock list:

1. Press , tap  > **Clock** > **World Clock** tab, and then press  > **Delete**.
2. Tap the cities you want to remove and tap **Delete**.

To manually set the time zone, date, and time:

To set the time zone, date, and time on your device manually, you need to turn off auto time synchronization first.



1. Press  and then tap the HTC Clock widget on the Home screen.
2. Tap the **World Clock** tab.
3. Press  and then tap **Local time settings** to open the Date & time settings screen.
4. Clear the **Automatic** check box.
5. Tap **Select time zone**. Scroll through the list and then tap the time zone that you want.
6. To change the date, tap **Set date**. Adjust the date by sliding your finger up or down on the day, month, and year, and then tap **Done**.
7. To change the time, tap **Set time**. Adjust the time by sliding your finger up or down on the hour and minute, and then tap **Done**.
8. Tap the **Use 24-hour format** check box to switch between using a 12-hour or a 24-hour time format.
9. Tap **Select date format** then select how you want dates to be displayed. (The selected date format also applies to the date displayed in the alarm clock.)

Alarm Clock

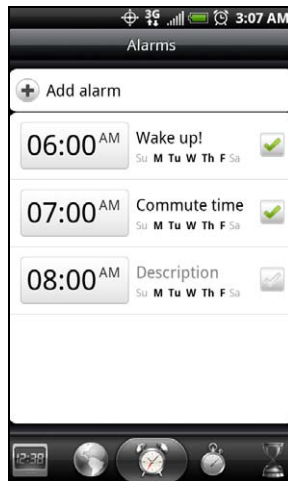
Your device comes with a built-in alarm clock that has multiple alarm capabilities.



Setting an Alarm

1. Press  and tap  > **Clock** > **Alarms** tab.
2. Tap one of the default alarms on the screen.
3. In the Set alarm screen, set the alarm time by sliding your finger up or down on the numbers and AM/PM.
4. Enter the alarm **Description**, set the **Alarm sound** and **Repeat**, and select the **Vibrate** check box if you want the device to also vibrate when the alarm goes off.
5. Tap **Done**.

Tip: If you need to set more than 3 alarms, you can add more alarms by tapping **Add alarm**.



Note: You can temporarily disable an alarm by clearing the check box () of the alarm on the **Alarms** tab.

Deleting an Alarm

1. On the **Alarms** tab, press  and tap **Delete**.
2. Select the alarms you want to delete and then tap **Delete**.

Changing Alarm Sound Settings

If you've set one or more alarms, you can change their settings such as the alarm volume, how long to snooze the alarm, and more.



1. Press  and tap  > **Clock** > **Alarms** tab.
2. Press  and tap **Settings**. You can change the following settings:
 - **Alarm in silent mode** This option is selected by default, which allows the alarm to sound even when your device's volume is set to silent mode. Clear this check box if you want to silence the alarm when the volume is in silent mode.
 - **Alarm volume** Set the volume level that you want for the alarm.
 - **Snooze duration** Set how long to snooze between alarms.
 - **Side button behavior** Choose what happens to the alarm when pressing the volume buttons of your device. You can set the button to snooze, dismiss the alarm, or disable the button. The side button works only when the device's screen is not locked. While on the lock screen, tap the onscreen **Snooze** button to snooze, or slide down the screen to dismiss the alarm.

Quickoffice

Quickoffice lets you view Microsoft Office Word, Microsoft Office Excel, and Microsoft PowerPoint files on your device. Quickoffice supports viewing of Microsoft Office 2003 and 2007 Word (.doc), Excel (.xls), PowerPoint (.ppt) and text (.txt) files.

Viewing Documents, Presentations, and Spreadsheets

Make sure you have copied the files to the device's microSD card before you open Quickoffice.

1. Press  and tap  > **Quickoffice**. (You may need to scroll down the screen to see the icon.)
2. Tap the file you want to open.

Tip: In the Open file screen, press  and tap **Sort** to let you sort the list by name or date.

3. Slide your finger on the screen to scroll horizontally or to flip through the pages of the file.

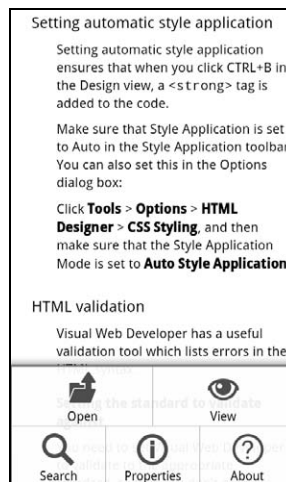

Quickoffice while viewing a Word document

4. While viewing a file:
 - Pinch the screen to zoom in or out or use the zoom controls on the screen to zoom in or out.
 - For Excel files, press  and then tap **Worksheet** to view other worksheets on the file.
 - For Word and PowerPoint files, tap a URL link to open the Web page in the browser.
 - When you open Word documents, Quickoffice reflows the text to make it fit the width of the screen. Double-tap the screen to switch to continuous view so you can view the page layout.



Note: Quickoffice does not reflow text in tables.

- When you view PowerPoint files, after your zoom in on a slide, you can double-tap the screen to zoom out automatically and fit the slide to the width of the screen.

PDF Viewer

Use PDF Viewer to view PDF files that you have copied to the device's microSD card.

Viewing a PDF File

1. Press  and tap  > **PDF Viewer**. (You may need to scroll down the screen to see the icon.)
2. On the Open file screen, tap the file you want to view.
3. Slide your finger on the screen to pan or go through the pages of the PDF file. While viewing a PDF file, press  to let you open another PDF file, zoom in, search the file, and more.

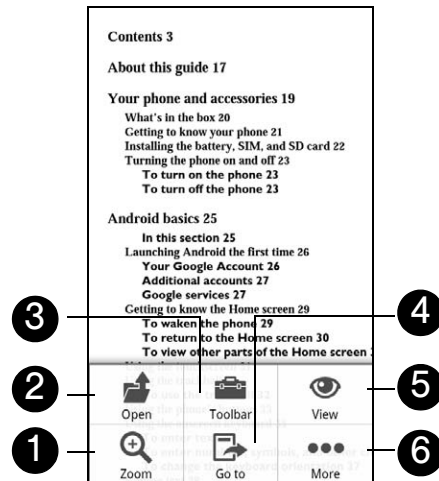

1. **Zoom** to zoom in on the page. You can also tap the screen quickly twice to zoom in or out of the page.
2. **Open** to open another PDF file.
3. **Toolbar** to toggle between showing and hiding the page toolbar.
4. **Go to** to go to a specific page on the PDF file.
5. **View** to let you change the view: **Continuous** or **Reflow**.
6. **More** to search for text in the PDF file, and view properties or information about PDF Viewer.

HTC Sync

HTC Sync™ lets you synchronize Outlook and Windows Address Book (Outlook Express) contacts and calendar events on your computer with your device. It also lets you back up and sync these information from your device back to your computer before you do a factory reset or a software (ROM) upgrade of your device. HTC Sync also enables you to install third-party Android applications on the device.

Here's what you'll need to do to install, set up, and use HTC Sync on your computer:

1. Use the HTC Sync installer that's in the supplied microSD card to install. For the steps on how to install, see "Installing HTC Sync From the microSD Card."
You can also download and install HTC Sync from the HTC support website. See "Downloading the Latest HTC Sync Upgrade" for details.
2. Connect your device to your computer using the supplied USB cable and set up HTC Sync to recognize your device. Follow the steps in "Setting Up HTC Sync to Recognize Your Device."
3. Choose what information to sync between your computer and your device and how you want to sync them.
 - To easily set up synchronization using HTC Sync's guided wizard, follow the steps in "Setting Up Synchronization."
 - To choose from more sync options, see "Setting up More Sync Options."
4. Sync your computer with your device automatically or manually. See "Synchronizing Your Device" for details.

Installing HTC Sync From the microSD Card

The HTC Sync version in the microSD card that came with your device can be installed in Windows 7, Windows Vista, and Windows XP.

Make sure that the microSD card is inserted on your device. Copy the HTC Sync installer from the microSD card to your computer and use it to install.

Important: HTC Sync requires USB 2.0 on your computer to connect and sync with your device. To see a complete list of the computer and software requirements, you can check them in the HTC Sync software download page on the HTC support website:
http://www.htc.com/www/SupportViewNews.aspx?dl_id=847&news_id=471

For trouble-free installation, first quit all running programs and temporarily disable your anti-virus program before you start installing HTC Sync.

1. Connect your device to your computer using the USB cable that came with your device.
2. On the Connect to PC screen on your device, tap **Disk drive** and then tap **Done**.
3. After you've selected disk drive mode on your device, your computer will treat your device as a removable disk (just like any USB drive). Open this removable disk so you can see what's inside the microSD card.
4. Copy **HTCSync.exe** to your computer.
5. After copying, unmount the removable disk (that is, the connected device) as required by your computer's operating system to safely remove your device.
6. On your computer, double-click **HTCSync.exe** and follow the onscreen instructions to install HTC Sync.

Setting Up HTC Sync to Recognize Your Device

After installing, set up HTC Sync to recognize your device.

1. Connect your device to the computer with the supplied USB cable. Or, if your device is already connected, press and hold the status bar and drag your finger down to open the Notifications panel. Then tap the status that shows **Select to change USB connection type**.
2. On the Connect to PC screen in your device, tap **HTC Sync** and then tap **Done**.
3. Your device attempts to find HTC Sync on your computer. Wait for a few seconds for the process to finish

Note: If your device displays a message indicating that it's unable to find HTC Sync, try disconnecting and reconnecting the USB cable, and then repeat step 2.

4. When your device finds HTC Sync, your computer will display the Phone Connection Wizard. Click **Next**.
5. Enter the name you want for your device, and then click **Finish**.
6. Check the HTC Sync icon at the bottom-right side of your computer screen. If it appears green in color, that means your device has successfully connected with your computer and HTC Sync recognizes your device.



Setting Up Synchronization

You can set up HTC Sync to synchronize your computer's Outlook contacts and calendar events with your device. If you're using Outlook Express on your computer, you can only sync contacts with your device.

Important: Before you begin setting up synchronization, make sure you have set up HTC Sync to recognize your device. If you have not yet done so, follow the steps in "Setting Up HTC Sync to Recognize Your Device."

1. On your computer, make sure the HTC Sync icon  at the bottom-right side of the screen appears in green, which means that your device is connected to HTC Sync.
2. Double-click the green HTC Sync icon on your computer to open HTC Sync.
3. Click **Synchronize Now**. (You can also click **Sync Manager > Settings**.)
4. In the Synchronization Settings Wizard, click **Next**.
5. In the next few dialog boxes, choose whether to sync Outlook or Outlook Express, select the type of information to sync (contacts or calendar), and choose to sync them automatically or manually with your device.
6. Click **Finish**.
HTC Sync then starts to sync your device and your computer. Wait for the synchronization to finish.
7. A summary report is then displayed. Click **Close**.

Setting up More Sync Options

HTC Sync gives you the flexibility to set many options, such as setting a sync schedule, choosing how to resolve conflicts when the same items are found on both the device and the computer, and more.

1. On your computer, make sure the HTC Sync icon  at the bottom-right side of the screen appears in green, which means that your device is connected to HTC Sync.
2. If HTC Sync is not open, double-click the green HTC Sync icon to open it.
3. Click **Sync Manager > Settings**.
4. In the Synchronization Settings Wizard dialog box, click **Manual settings**.



5. From the left side of the Sync Manager Settings dialog box, click the type of setting you want to change, and then choose from the available options on the right. Settings that can be changed include the following:
 - **Contacts or Calendar folder to sync with** Change this only if you have personal folders created in your Outlook and you need to sync with a personal folder. Click **Contacts** or **Calendar** on the left side of the dialog box, click the **Properties** button, and then choose the personal folder to sync with.
 - **Calendar events to sync with** Choose the number of days of calendar events to sync. Click **Calendar** on the left side of the dialog box, click **Properties**, and then set the days under **Date range**.
 - **Conflict policy** In cases when the same contacts or calendar items exist in both your device and your computer, choose whose data you want to keep when a conflict occurs.
 - **When to sync** Click **Automatic sync** on the left side of the dialog box. Then choose whether to sync manually, auto sync everytime you connect your device to your computer, or sync at a set schedule.
6. Click **Apply** to save the sync options you've selected, and then click **OK**.

Synchronizing Your Device

After you've installed and set up HTC Sync, you can sync your device with your computer.

Synchronizing Your Device Automatically with Your Computer

Do the following first to make sure your device will sync automatically with your computer:

1. Press  > , and then tap **Settings > Applications > Development**.
2. Make sure the **USB debugging** check box is selected.
3. Whenever you connect your device to your computer, synchronization starts automatically. Wait for the sync process to finish.

Synchronizing Your Device Manually with Your Computer

1. Connect your device to the computer with the supplied USB cable. Or, if your device is already connected, press the status bar and drag your finger down to open the Notifications panel. Then tap the status that shows **Select to change USB connection type**.
2. On the Connect to PC screen in your device, tap **HTC Sync** and then tap **Done**.
3. On your computer, make sure that the HTC Sync icon  at the bottom-right side of the screen appears in green, which means that your device is connected to HTC Sync.
4. On your device, tap **Sync now**.

Downloading the Latest HTC Sync Upgrade

Visit the HTC support website (www.htc.com/support) from time to time to check for the most recent HTC Sync upgrade so you can download and install it on your computer.

After installing the latest upgrade, set up HTC Sync again to recognize and sync with your device. Follow the steps in "Setting Up HTC Sync to Recognize Your Device" and "Setting Up Synchronization."

Installing Apps From Your Computer to Your Device

If you have applications (.apk files) on your computer, you can use HTC Sync to install them to your device. We strongly recommend you install only applications that you trust.

1. On your device, press  > , tap **Settings > Applications**, and then select the **Unknown sources** check box to allow applications from your computer to be installed to your device.

Note: You only have to do this step once. You do not need to do this step again next time you install another application from your computer to your device.



2. Connect your device to the computer with the supplied USB cable. Or, if your device is already connected, press the status bar and drag your finger down to open the Notifications panel. Tap the status that shows **Select to change USB connection type**.
3. On the Connect to PC screen in your device, tap **HTC Sync** and then tap **Done**.
4. On your computer, double-click the green HTC Sync icon  to open HTC Sync.
5. In HTC Sync, click **Application Installer**.
6. In the Application Installer file types dialog box, make sure that the **Android OS installer file (apk)** check box is selected, and then click **OK**.

Note: This dialog box only appears the first time you use the Application Installer.

7. Click **Next**.
8. Click **Browse**, locate the application (.apk) on your computer, and then click **Open**.
9. After selecting the application, click **Next**.
10. Click **Finish**. Check your device's screen to see if there are additional instructions to complete the installation.

Updating Your Device

To download software updates to your device:

- ▶ Press  >  > **Settings > System updates > Firmware update**. (Your device automatically downloads and installs any available updates. You may be required to power your device off and back on to complete the software upgrade.)



2F. Voice Services

- ◆ Automatic Speech Recognition (ASR) (page 69)
- ◆ Managing Voice Memos (page 70)

Automatic Speech Recognition (ASR)

You can use your device's built-in automatic speech recognition (ASR) software to dial a phone number in People or to launch device functions. All you have to do is to talk into the device, and ASR will recognize your voice and complete tasks by itself.

Activating ASR

▶ Press  and tap  > **Voice Dialer**. (You may need to scroll down the screen to see the icon.)

The screen displays “Listening...” and the device prompts you to say the name of the command you want to use. To complete your task, simply follow the voice prompts.



Available ASR commands include:

- **Call** <Name or Voicemail> to call an entry in your People list or voicemail. (See “Making a Voice Call With ASR.”)
- **Dial** <Number> to dial a spoken phone number.
- **Redial** to dial the last outgoing call.
- **Open** <Application Name> to open an application in your device. (See Opening Applications With ASR)

Tip: Use ASR in a quiet environment so it can accurately recognize your commands.

Note: Regardless of which command you use, you will be asked to confirm your choice, or choose from a menu if ASR is not sure what you would like to do.

Making a Voice Call With ASR



1. Press  and tap  > **Voice Dialer**.
2. Wait until you hear a tone and the word “Listening...” appears on the screen.
3. Say “Call [contact name]” to call a person stored in your People list.
– or –
Say “Dial [contact number]” to dial a spoken phone number.

Note: When dialing a phone number, numbers can be three digits (for example, 911), seven digits (for example, 555-1234), or ten digits (for example, 222-555-1234).

4. Tap **YES** to confirm or **CANCEL** to cancel the command; or choose from a menu if ASR is not sure what you would like to do.

Opening Applications With ASR



You can jump directly to many applications by saying “Open” followed by the application name.

1. Press  and tap  > **Voice Dialer**.
2. Wait until you hear a tone and the word “Listening...” appears on the screen.
3. Say “Open [application name]” to open an application in your device.
4. Tap **YES** to confirm or **CANCEL** to cancel the command; or choose from a menu if ASR is not sure what you would like to do.

Managing Voice Memos

Use your device’s Voice Recorder to record brief memos to remind you of important events, phone numbers, grocery list items, or create a ring tone.

Recording Voice Memos



1. Press  and tap  > **Voice Recorder**. (You may need to scroll down the screen to see the icon.)
2. Tap  and speak into the device’s microphone.

To end the recording of your memo:



- ▶ Tap .

Voice Memo Options

To play the voice memos you have recorded:



- ▶ After recording a voice memo, tap .
- or –
- Tap  and then tap the file you want to play.

To share a voice memo:



1. Press  and tap  > **Voice Recorder**.
2. On the Voice Recorder screen, tap .
3. On the All recordings screen, press and hold the voice memo you want to share, and then tap **Share** on the options menu.
4. On the Share options menu, select how you want to share the voice memo.

To learn how to send files using Bluetooth, see “Bluetooth” on page 94.





To set a voice clip as a ring tone

1. Press  and tap  > **Voice Recorder**.
2. On the Voice Recorder screen, tap .
3. On the All recordings screen, press and hold the voice memo you want to set as a ring tone, and then tap **Set as ringtone** on the options menu.

Renaming Voice Memos

1. Press  and tap  > **Voice Recorder**.
2. On the Voice Recorder screen, tap .
3. On the All recordings screen, press and hold the voice memo you want to rename, and then tap **Rename** on the options menu.
4. Enter the new name and tap **Save**.

Erasing Voice Memos

1. Press  and tap  > **Voice Recorder**.
2. On the Voice Recorder screen, tap .
3. On the All recordings, press  and then tap **Delete**.
4. Do any of the following:
 - To erase one or more voice memos, select the check boxes at the right side of the voice memo names, and then tap **Delete**.
 - To erase all voice memos, press , tap **Select All**, and then tap **Delete**.

2G. microSD Card

- ◆ Your Device's microSD Card (page 72)
- ◆ Using the Device's microSD Card as a USB Drive (page 74)

Your Device's microSD Card

The microSD Card

Your device is equipped with a 2 GB microSD™ (Secure Digital) memory card to expand the device's available memory space. It allows you to store images, videos, music, documents, and voice data in your device.

Important: Your device comes with the microSD card preinstalled.

Removing the microSD Card

1. With the device turned off, insert your fingernail into the slot at the top left of the battery compartment cover and lift gently to remove.
2. Lift the battery from the notches on the upper left and right sides of the battery compartment, and then set it aside.
3. Locate the latch at the bottom-right corner of the battery compartment, and then lift the latch to unlock the microSD card slot.

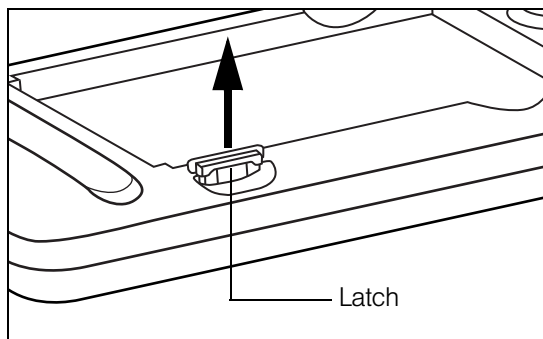

4. Gently pull the microSD card out from the slot, and then press the latch back to lock position.

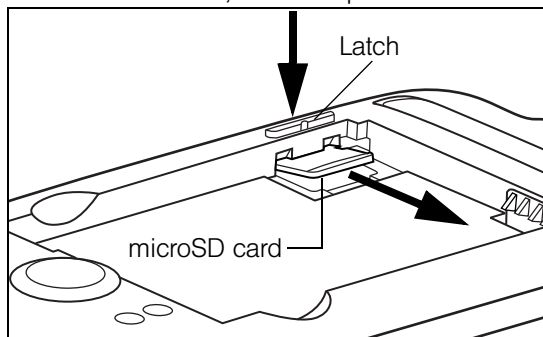

5. Re-install the battery and the back cover. For more information on how to remove and re-install the back cover and battery, see "Battery and Charger" on page 12.

Note: You can easily damage the microSD card by improper operation. Please be careful when inserting, removing, or handling the microSD card.

Make sure your battery is fully charged before using the microSD card. Your data may become damaged or unusable if the battery runs out while using the microSD card.

Inserting the microSD Card

1. With the device turned off, insert your fingernail into the slot at the top left of the battery compartment cover and lift gently to remove.
2. Lift the battery from the notches on the upper left and right sides of the battery compartment, and then set it aside.
3. Locate the latch at the bottom-right corner of the battery compartment, and then lift the latch to unlock the microSD card slot.

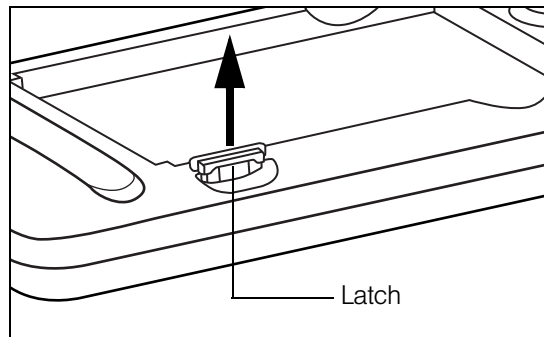

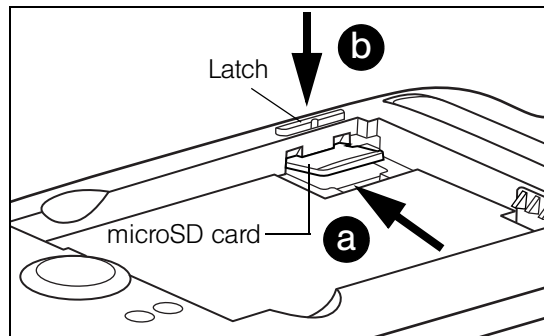

4. Carefully insert the microSD card into the slot (a), and then press the latch (b) to lock the slot and secure the card in place.





5. Re-install the battery and the back cover. For more information on how to remove and re-install the back cover and battery, see "Battery and Charger" on page 12.

Viewing the microSD Card Memory

- ▶ With the microSD card inserted, press  >  and tap **Settings > SD & phone storage**. (The total and available memory space will be displayed.)

Formatting the microSD Card

Formatting a microSD card permanently removes all files stored on the card.

1. Press  >  and tap **Settings**.
2. Scroll down the screen, tap **SD & phone storage > Unmount SD card > Format SD card > Format SD card > Erase everything**.

Note: The formatting procedure erases all the data on the microSD card, after which the files CANNOT be retrieved. To prevent the loss of important data, please check the contents before you format the card.

When you unmount the SD card, you need to remove and then reinsert the microSD card or turn the device off and then on for the device to recognize the microSD card again.

Unmounting the microSD Card

When you need to remove the microSD card, you must unmount the microSD card first to prevent corrupting the data inside or damaging the microSD card. Since you will remove the battery first before you can remove the microSD card, close all running applications on your device and save any data before doing this.

1. Press  >  and tap **Settings**.
2. Scroll down the screen, tap **SD & phone storage > Unmount SD card**.
3. Remove the microSD card by following the instructions in “Removing the microSD Card” on page 72.

Using the Device’s microSD Card as a USB Drive

To transfer music, pictures, and other files from your computer to your device's microSD card, you need to set the device's microSD card as a USB drive.

1. Connect the device to your computer using the supplied USB cable.
2. When the Connect to PC dialog box appears, tap **Disk drive**, and then tap **Done**.
3. On your computer, the connected device is recognized as a removable disk. Navigate to this removable disk and open it.
4. Do one of the following:
 - Copy files from the computer to the device's storage card's root folder.
 - Copy files from the device's storage card to a folder in your computer or computer desktop.
5. After copying the files, unmount the removable disk (that is, the connected device) as required by your computer's operating system to safely remove your device.
6. Do one of the following:
 - Disconnect the device from the computer.
 - If you want to keep the device connected to the computer but want the device to be able to access and use the storage card, open the Notifications panel, tap **Disk drive**, select an option except **Disk drive**, and then tap **Done**.

Note: The device will not recognize the microSD card when it is connected to a computer as a disk drive. You will not be able to use some of the device's applications such as the camera or Music.

2H. Camera and Multimedia





- ◆ Taking Pictures and Shooting Videos (page 75)
- ◆ Viewing Pictures and Videos Using Gallery (page 81)
- ◆ Sharing Live Videos with Qik (page 88)
- ◆ Listening to Music (page 88)
- ◆ Listening to the Radio (page 92)

Taking Pictures and Shooting Videos

You can use the camera or camcorder to take and share pictures and videos. Your device comes with a 8.0 megapixel main camera with autofocus feature that lets you capture sharp pictures and videos. A 1.3 megapixel front camera is also available for self-portrait and video capture.

Important: Make sure the microSD card is installed before you use the camera or camcorder. All pictures or videos that you capture using your device are stored on the microSD card. For more information on how to install a microSD card on your device, see “Inserting the microSD Card” on page 73.

Opening the Camera

- ▶ To open the camera in photo mode and take photos, press  and then tap  > **Camera**.
- ▶ To open the camera directly in video mode so you can immediately start capturing videos, press  and tap  > **Camcorder**.

Viewfinder Screen

The camera controls are oriented to landscape view, although you take pictures in portrait format also. You'll find the following controls on the Viewfinder screen:



1. **Menu tab** opens the menu panel and lets you change the camera settings. For more information, see “Camera Settings.”
2. **Autofocus indicator** Whenever you point the camera at a different subject or location, the screen shows the autofocus indicator at the center as the camera automatically focuses on the center of the screen. When you tap another area on the screen, the indicator will move to where you tapped and the camera will automatically focus on that area. The autofocus indicator is not available when you are using the second (front) camera.
3. **Flash button** Tap to switch between various camera flash modes.

4. **Zoom button** displays or hides the onscreen zoom bar. For more information, see “Zooming.” The zoom button is not available when you are using the second (front) camera.
5. **Shutter release button** Tap this button to take a photo or begin capturing video. Tap it again to stop capturing video.
6. **View button** Opens the Gallery application so you can browse through and view the photos and videos in your storage card. For more information, see “Viewing Pictures and Videos Using Gallery.”

Review Screen

After capturing a photo or video, the review screen lets you save, view, send, or delete the picture or video by tapping a button at the bottom of the screen.





1. Go **Back** to the live camera or camcorder screen.
2. **Delete** the captured image or video.
3. **Share** the captured photo or video to another phone or your computer using Bluetooth, send it by email or multimedia message, or select a social network where you want to upload it to.
4. **View** the captured image or video in Gallery.

Zooming

Before taking a photo or video, you can first use the onscreen zoom bar to zoom in or out of your subject.

1. To display the onscreen zoom bar, tap the zoom button . You can also slide your finger up or down the viewfinder screen. While the zoom bar is shown on the viewfinder screen, you will also see the remaining photo shots or remaining video recording duration on the upper-right side of the screen.
2. You can do the following:
 - To slowly zoom in or out, slide your finger up or down the viewfinder screen. You can also drag your finger along the zoom bar.



- Tap  to zoom in to the highest magnification.
- Tap  to zoom out to the actual size.

3. After you're done, wait for a few seconds for the zoom bar to automatically disappear from the screen. You can also tap the zoom button again or tap the viewfinder screen to hide it.

Note: Zooming is not available when you are using the second (front) camera.

Face Detection

When you're autofocusing the device's camera to take photos of people, the camera can automatically recognize faces and adjust the focus.

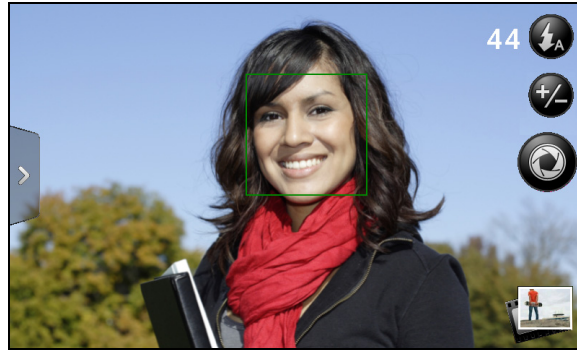

Note: Face detection does not work in video mode and is not available when you are using the second (front) camera.

Taking Pictures

1. Press and then tap > **Camera**.
2. Before taking the photo, you can zoom in on your subject. For more information, see “Zooming.”
3. On the Viewfinder screen, tap the flash button repeatedly to select a camera flash mode depending on your lighting conditions:
 - Auto flash
 - Flash on
 - Flash off

4. Frame your subject on the screen.

Tip: Hold the device vertically when taking portrait shots or hold the device horizontally when taking landscape shots. By doing this, you do not need to rotate the photo after capturing it.

5. You can either let the camera autofocus on the center of the screen, or you can touch another area on the screen that you want to focus on.

Note: The second camera (front) is fixed-focus and does not support zooming and face detection.

6. Tap to take the photo.
7. Choose what you want to do with the photo you've just taken. See “Review Screen” for details.



Camera Flash FAQ

Camera flash light doesn't turn on?

The flash light quickly consumes battery power. To save battery power, the camera disables the flash light or locks it to **Flash off** mode (even when you have set it to **Auto flash** or **Flash on**) when one of the following occurs:

- You have an incoming call. If you have set the flash light to **Flash on**, it turns back on after you answer and end the call.
- Your device's battery level reaches 20% or lower. Recharge the battery so that the camera can have enough battery power to use the flash light.
- Cold weather lowers battery performance and affects the flash light. To make sure the camera has enough battery life to power up the flash light, keep your device warm. When not in use, put the device inside your jacket to keep it warm, and try to avoid sudden temperature changes that may affect battery performance.

Capturing Videos

1. Press  and then tap  > **Camcorder**.
2. Before capturing the video, you can zoom in on your subject. For more information, see “Zooming.”
3. Frame your subject on the screen.
4. You can either let the camcorder autofocus on the center of the screen, or you can touch another area on the screen that you want to focus on.
5. Tap  to start capturing video.



6. Tap  again to stop capturing.
7. Choose what you want to do with the video you've just captured. See “Review Screen” for details.

Camera Settings

Open the menu panel to change basic camera settings and access more camera settings. You can also switch between photo and video modes from the menu panel.

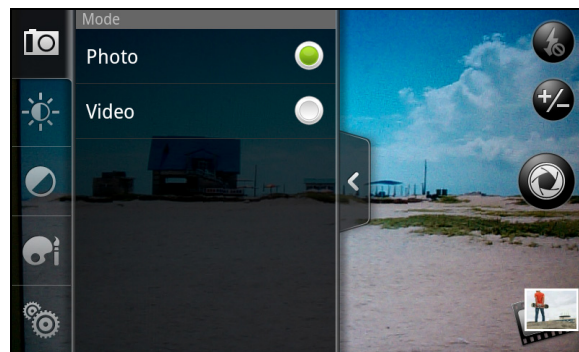

Changing Basic Settings

1. On the viewfinder screen, tap  to open the menu panel.

2. To change basic camera settings, tap one of these icons in the menu panel:

- Exposure 

There's a brightness bar that allows you to adjust the brightness level. Slide your finger up or down the brightness bar to increase or decrease brightness.

- Image properties 

Slide your finger across each of the slider bars to adjust the contrast, saturation, and sharpness.

- Effect 

You can apply a special effect to photos and videos that you will capture. Scroll through the Effect menu and choose from effects such as adding a sepia tone, solarization, and posterizing.

Changing Advanced Settings

1. On the viewfinder screen, tap  to open the menu panel.

2. Tap  in the menu panel to display the Settings menu and access more camera settings. You can change the following settings from the Settings menu:

- **Switch camera:** Lets you switch between the main camera and the second (front) camera.

- **White balance:** Lets you change the white balance to enable the camera to capture colors more accurately by adjusting to your current lighting environment. White balance settings include: **Auto**, **Incandescent**, **Fluorescent**, **Daylight**, and **Cloudy**.

- **ISO (photo mode only):** Lets you choose an ISO level or set it back to **Auto**. Higher ISO numbers are better for taking pictures in low light conditions. This option is not available when you are using the second (front) camera.

- **Resolution:** Lets you select a photo or video resolution to use for capturing.

- **Widescreen (photo mode only):** Lets you change the ratio between the width and height of your pictures. When this check box is selected (default), photo resolutions available for selection are in a 3:2 ratio and you can use the entire viewfinder screen to frame your subject. When not selected, photo resolutions available for selection are in a standard 4:3 ratio. This option is not available when you are using the second (front) camera.

- **Storage:** Lets you select where to save captured photos or videos. You can select the storage card or internal memory, if available.

- **Quality (photo mode only):** Lets you select the quality level to use for capturing photos.

- **Self-timer (photo mode only):** Lets you select take a self-portrait or group photo; you can set the self-timer to either 2 seconds or 10 seconds.
- **Geo-tag photos (photo mode only):** Lets you store the GPS location in your captured photos.
- **Encoding type (video mode only):** Lets you choose the type of compression to use when capturing video.
- **Recording length (video mode only):** Lets you set the maximum duration or file size for capturing video.
- **Record with audio (video mode only):** Lets you choose whether to record audio when capturing videos.
- **Metering mode:** Lets you set how the camera measures the amount of light to calculate the best exposure:
 - **Spot metering** mode allows the camera to measure light around the focus point.
 - **Center area** mode allows the camera to measure light in the center.
 - **Average** mode allows the camera to measure light in the whole image.

This option is not available when you are using the second (front) camera.
- **Review duration:** Lets you specify how long a captured photo or video is displayed on the review screen before the camera changes back to the viewfinder screen.
- **Flicker adjustment:** Lets you reduce flicker when taking indoor shots under fluorescent lighting. Keep this setting on **Auto** or manually set it to match the frequency (**50Hz** or **60Hz**) of the electrical power used for the country you are in.
- **Auto Focus:** Enables or disables centered autofocus. Autofocus is enabled by default. This option is not available when you are using the second (front) camera.
- **Face detection:** Allows the camera to recognize faces and automatically adjust the focus. Face detection is turned off when you disable **Auto Focus** and is not available when you are using the second (front) camera.
- **Shutter sound:** Allows you to select whether the camera plays a shutter sound when you press the shutter release.
- **Time stamp (photo mode only):** Lets you add the date and time to captured photos.
- **Grid (photo mode only):** Allows you to display a grid on the viewfinder screen so you can easily frame and center your subject before taking the photo.
- **Reset to default:** Lets you change the camera back to default settings.

Closing Camera

On the camera screen, press  or .

Viewing Pictures and Videos Using Gallery

Using the Gallery application, you can view photos and watch videos that you've taken with your device's camera, downloaded, or copied onto your storage card. You can also take a look at your photos and your friends' photos that are on your social networks (Facebook and Flickr only).

For photos that are in your storage card, you can do basic editing such as rotating and cropping. You can also easily make a photo as your contact picture or wallpaper and share photos with your friends.

Opening Gallery

► Press  and tap  > **Gallery**.

The Gallery application opens in the Albums tab where your photos and videos are organized by albums for easy viewing.

If you stored your files in folders (directories) on the microSD card, Gallery will display these folders as separate albums.



1. **Camera shots** lets you view photos and videos that are stored in the camera's folder.
2. **All photos** lets you view all photos that are stored in all the folders on the storage card.
3. **All videos** lets you view all videos that are stored in all the folders on the storage card.
4. Photos and videos that you set as your favorites will be grouped under **Favorites**.

Photos or videos that are under the root path of your storage card (that are not contained in folders) are grouped in **Others**.

Folders in your storage card that contain photos and videos will also be treated as albums and will be listed below the preset albums. The actual folder names will be used as the album names. If you have downloaded any photos and videos, these will be placed in the **All downloads** album.

When viewing pictures in Gallery, scroll up the screen to view more albums. Simply tap an album to view the photos or videos in that album.

Note: Depending on the number of pictures stored on the microSD card, it may take awhile for Gallery to load all your photos on the screen.

Viewing Photos and Videos

After selecting an album from the Albums tab, you can browse through the photos and videos of that album either in filmstrip or grid view. Tap a photo or video to view it in full screen.

By default, photos and videos are presented in a horizontal filmstrip. Slide your finger left or right across the filmstrip to go through the photos and videos.

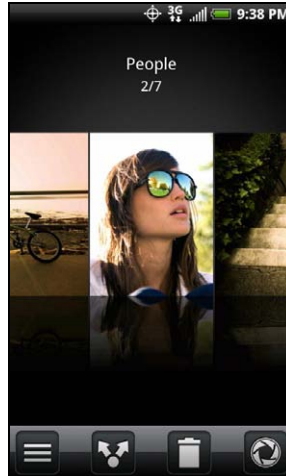

From the filmstrip view, press  and then tap **Grid view** to browse photos and videos by thumbnails. Slide your finger up or down to scroll through the thumbnails.

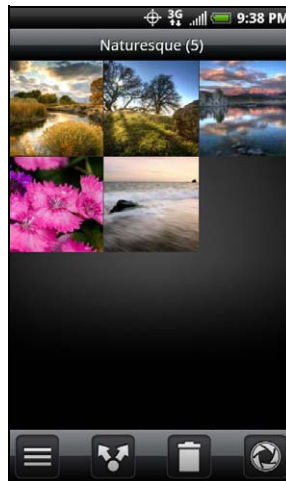

To change back to displaying photos and videos in a filmstrip, press  and then tap **Filmstrip view**.

Note: Whether you're in filmstrip or grid view, you can press and hold on a photo or video to open a selection menu and choose what to do with the photo or video.

If you want to select another album, tap  to return to the Albums tab.

Zooming In or Out on a Photo

There are two ways you can zoom in or out of a photo:

- ▶ Tap the screen twice quickly to zoom in, then tap the screen twice quickly again to zoom out.
– or –

You can also use pinch zooming. Press your thumb and index finger on the screen and then spread your fingers apart to zoom in. Pinch your fingers together to zoom out.

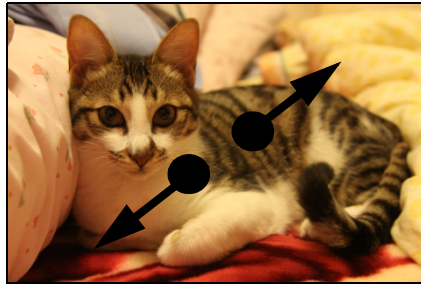

Zooming in

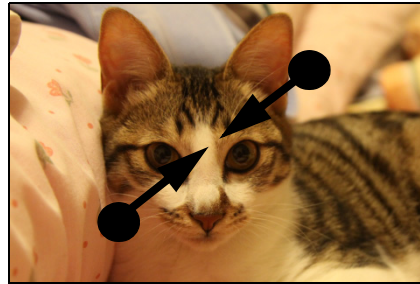

Zooming out

Watching Video

The screen automatically switches to landscape mode when you play a video. Use the onscreen controls to play, pause, or stop the video.

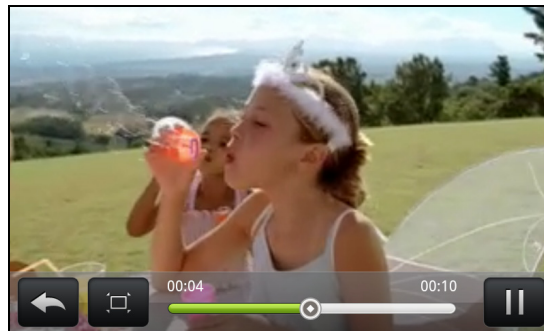

The video is displayed in full screen size. You can tap  to make it best fit on the screen based on the video size. Tap the button again to change back to full screen size.

You can play these high-definition MP4 video formats in **Gallery**:

- H.263 profile 0 @ 30 fps, WVGA (800x480), max 2 Mbps
- MPEG-4 simple profile @ 30 fps, 720p (1280x720), max 6 Mbps
- H.264 baseline profile @ 30 fps, 720p (1280x720), max 6 Mbps

Viewing Photos in Your Social Networks

Using Gallery, you can view your photos and your friends' photos that are in your social networks (Facebook and Flickr only).

Viewing Photos on Facebook

You need to be logged in to your Facebook account to view Facebook photos.



1. Press  and tap  > **Gallery**.

2. Tap the **Facebook** tab.
3. Tap your account name or your friend's account on the list to view the pictures in the account.

You can view photos in your online albums the same way as how you view photos in your storage card.

Viewing Photos on Flickr

You need to be logged in to your Flickr account to view Flickr photos.



1. Press  and tap  > **Gallery**.
2. Tap the **Flickr** tab.
You may be asked to give authorization for the application to connect to the Flickr website. If this happens, you need to give authorization to access your Flickr account.
3. Tap your account name or your friend's account on the list to view the photos in the account.

You can view photos in your online albums the same way as how you view photos in your storage card.

Viewing Photos and Videos on Another Display Device

An HDMI jack at the bottom panel of your device lets you connect it with an HDMI-compliant external display device such as an LCD TV.



Note: An HDMI cable must be purchased separately. It is not included with your device. (An HTC-approved HDMI cable may be purchased at www.sprint.com/accessories.)

1. Connect one end of the HDMI cable to the HDMI jack at the bottom panel of your device.
CAUTION! Inserting an accessory into the incorrect jack may damage the device.
2. Make sure the external display device is turned off, and then connect the other end of the HDMI cable to the HDMI jack on the external display device.
3. Turn on the external display device and then select the HDMI video input. Refer to the display's documentation for details.
4. On your device, press  and tap  > **Gallery**.
5. Open a photo or video album, and then do any of the following:
 - Start a photo slideshow by pressing  and tapping **Slideshow**.
 - Tap a video to start playing it on the screen.
 The device screen should show on the external display device.

Working with Photos



Whether you're browsing photos in filmstrip or grid view in the Gallery application, you can press and hold on a photo to open a selection menu and choose what to do with it. You can choose to delete the photo, rotate or crop it, and more.

Rotating and Saving a Photo

1. Press  and tap  > **Gallery**.
2. On the Albums tab, tap an album.
3. Choose whether to browse photos and videos in the album in filmstrip or grid view. For more information, see "Viewing Photos and Videos."
4. Press and hold on the photo that you want to rotate.
5. In the menu that opens, tap **Rotate**, and then select either **Rotate left** or **Rotate right**.

Tip: You can also rotate a photo while you're viewing it in full screen. Press , tap **Rotate**, and then select either **Rotate left** or **Rotate right**.

Cropping a Photo

1. Press  and tap  > **Gallery**.
2. On the Albums tab, tap an album.
3. Choose whether to browse photos and videos in the album in filmstrip or grid view. For more information, see “Viewing Photos and Videos.”
4. Press and hold on the photo that you want to rotate.
5. In the menu that opens, tap **Crop**. A crop box then appears on the photo.

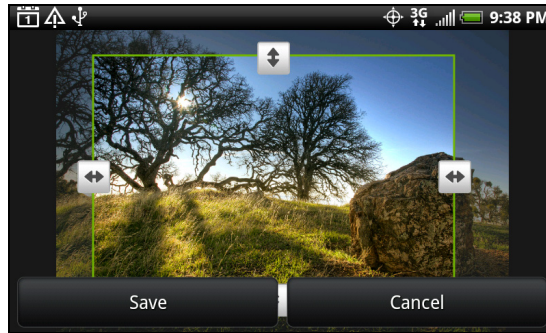

6. To adjust the crop box size, press and hold the edge of the box. When directional arrows appear, drag your finger inward to or outward to resize the crop box.
7. To move the crop box to the part of the photo that you want to crop, drag the crop box to the desired position.
8. Tap **Save** to apply the changes to the picture.

The cropped picture is saved in the storage card as a copy. The original picture remains unedited.



Tip: You can also crop a photo while you're viewing it in full screen. Press , tap **More** > **Crop**, and follow the same cropping steps as above.

Sharing Photos and Videos

The Gallery application lets you send photos and videos using email or multimedia message. You can share photos on your social networks (such as Facebook, Flickr, Picasa, and Twitter) and share videos on YouTube or Qik. You can also send them to another phone or your computer using Bluetooth.

Sending Photos or Videos by Email



You can send several photos, videos, or both in an email message. They are added as file attachments in your email.

1. Press  and tap  > **Gallery**.
2. Tap the album where the photos or videos you want to share are in.
3. Tap  and then on the Share options menu, tap **Gmail** or **Mail**.
4. Select the photos or videos you want to share and then tap **Next**.
5. Compose your message and then tap **Send**.

Note: If you selected **Mail** and you have multiple email accounts, the default email account will be used.



Sending a Photo or Video by Multimedia Message

Although you can send several photos or videos in a multimedia message, it may be better to just send one at a time, especially if the files are big in size.

1. Press  and tap  > **Gallery**.
2. Tap the album where the photos or videos you want to share are in.
3. Tap  and then on the Share options menu, tap **Messages**.
4. Tap the photo or video you want to send. The photo or video is automatically added into the multimedia message.
5. Compose your message and then tap **Send**.

Sending Photos or Videos Using Bluetooth



You can select several photos, videos, or both and send them to someone's phone or your computer using Bluetooth.

1. Press  and tap  > **Gallery**.
2. Tap the album where the photos or videos you want to share are in.
3. Tap  and then on the Share options menu, tap **Bluetooth**.
4. Select the photos or videos you want to share and then tap **Next**.

In the next few steps, you'll be asked to turn on Bluetooth on your device and connect to the receiving Bluetooth device so the files can be sent. For more information, see "Bluetooth" on page 94.



Sharing Photos on Facebook for HTC Sense

You need to be logged in to your Facebook account to be able to upload photos.

1. Press  and tap  > **Gallery**.
2. Tap the album where the photos you want to share are in.
3. Tap  and then on the Share options menu, tap **Facebook for HTC Sense**.
4. Select the photos you want to share and then tap **Next**.
5. Add a caption for the photos and then tap **Upload**.
6. Select which album to upload to and set privacy settings for the uploaded pictures. Tap **Done**.



Sharing Photos on Facebook for Android

You need to be logged in to your Facebook account to be able to upload photos. When using Facebook for Android, you can only upload one photo at a time.

1. Press  and tap  > **Gallery**.
2. Tap the album where the photos you want to share are in.
3. Tap  and then on the Share options menu, tap **Facebook**.
4. Select the photo you want to share and then tap **Next**.
5. Add a caption for the photo and then tap **Upload**.
6. Check the status bar for the upload information.

Sharing Photos on Flickr

You need to be logged in to your Flickr account to be able to upload pictures.





1. Press  and tap  > **Gallery**.
2. Tap the album where the photos or videos you want to share are in.
3. Tap  and then on the Share options menu, tap **Flickr**.
4. Select the pictures you want to share and then tap **Next**.
5. Add a description for the photos and then tap **Upload**.

Note: If you are not logged in to your Flickr account, you will be prompted to do so and download the HTC Flickr Downloader application. Follow screen instructions to proceed.

6. Select which album to upload to and set privacy settings for the uploaded pictures. Tap **Done**.



Sharing Photos on Picasa

You need to be signed in to a Google Account to be able to upload pictures to the Picasa™ photo organizing service.

1. Press  and tap  > **Gallery**.
2. Tap the album where the photos or videos you want to share are in.
3. Tap  and then on the Share options menu, tap **Picasa**.
4. Select the pictures you want to share and then tap **Next**.
5. Select the online album where you want to upload the pictures, or tap  to create a new album.
6. Tap **Upload**. You can view the photos online at <http://picasaweb.google.com>.

Sharing Videos on YouTube

You can share your videos by uploading them to YouTube™. Before you do this, you must create a YouTube account and sign in to that account on your device.

1. Press  and tap  > **Gallery**.
2. Tap the album where the photos or videos you want to share are in.
3. Tap  and then on the Share options menu, tap **YouTube**.
4. Select the videos you want to share and then tap **Next**.
5. Enter the prompted information, such as description and tags, and select a privacy option.
6. Tap **Upload**.

Closing Gallery





- ▶ While in the Gallery screen, press  to close the application.

Sharing Live Videos with Qik

Use Qik to share live videos from your device. Before you start sharing live videos in Qik, you must create and sign in to your Qik account. To create a Qik account, visit <http://qik.com> and click **Sign Up**.

Sharing a Live Video in Qik

Qik lets you stream live video from your device to your Qik account where your friends can view it.

1. Press  and tap  > **Qik**.
2. When prompted, sign in to your Qik account.
3. On the Qik screen, do any of the following:
 - Tap **Share** to share the video with specific contacts.
 - Tap **Title** to specify a title for the live video.
 - Tap **Public** to set the video privacy settings to **Private** or **Public**.
 - Press  and tap **Settings** to set up your sharing preferences, video quality, the camera to use, and more.
4. Tap  to start streaming live video to your Qik account. Tap  to stop streaming live video.



Closing Qik

- ▶ On the Qik screen, press  and tap **Exit**.

Listening to Music



Enjoy listening to songs and music on your device using the Music application. You need to copy music files to your storage card first to use the Music application to play music. To find out how to copy files to the storage card, see “Using the Device’s microSD Card as a USB Drive” on page 74.

Playing Music

To open the Music application, press  and tap  > **Music**.

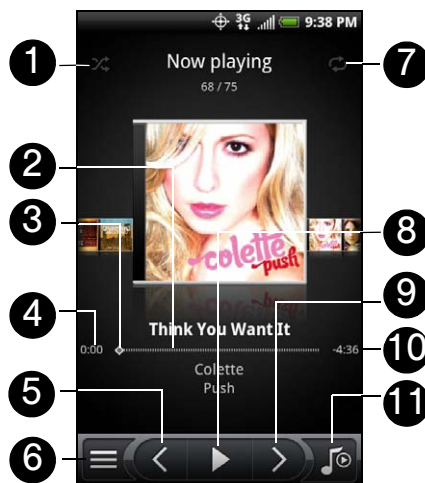
The Music application opens in the Playback screen. Use the onscreen controls to control music playback, select a song to play, repeat songs, and more. On the Playback screen, you can also swipe your finger from right to left or left to right to go to the next or previous music album.



1. Tap to turn shuffle on or off. (Shuffle is off when button is gray.)
2. Shows the progress bar.
3. Press and drag to jump to another part of the song.
4. Shows the elapsed time.
5. Tap to go to the previous song in the Now playing list.
6. Tap to go to the Library.
7. Tap to cycle through the repeat modes:  Repeat all songs,  Repeat current song, and  don't repeat.
8. Tap to pause or resume playing the song.
9. Tap to go to the next song in the Now playing list.
10. Shows the remaining time.
11. Tap to toggle between showing the Now playing list and Playback screen.

When you are playing music and the screen turns off, you can control the music playback right from the Lock screen when you “wake up” the device by pressing . If you do not see the playback controls on the Lock screen, tap anywhere on the screen to display the playback controls.

Tip: You can also swipe your finger from right to left or left to right to go to the next or previous song in the Now playing list.

Note: Press the volume up or down button to adjust the playback volume.

Browsing Music in the Library

Tap  at the bottom-left corner of the Playback screen or the Now playing list screen to go to the Library.

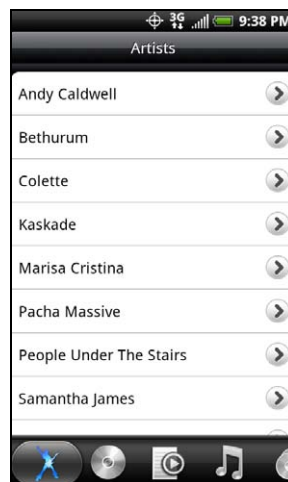

In the Library, your music is organized into different categories such as Artists, Albums, Playlists, Genres, Composers, and more. Select a category by tapping one of the category tabs at the bottom of the screen.



When you tap a song in a category to play it, the Now playing list is updated with the song list from your selected category.

Creating Playlists

Personalize your music experience by creating music playlists. Make a playlist containing just your favorite songs or create one to match your mood for the day. You can make as many playlists as you like.

1. Press  and tap  > **Music**.
2. Tap  at the bottom-left corner of the screen to go to the Library.
3. In the Library, tap or slide your finger on the bottom row to go to the Playlists category.
4. Tap **Add playlist**.
5. Enter a playlist name, and then tap **Add songs to playlist**.
6. Tap or slide your finger on the bottom row to change among the different categories. If you go to the Songs category, you can see a complete list of songs on your storage card.
7. Select the check boxes of songs you want to add to the playlist and then tap **Add**.
8. Tap **Save**.

Playing the Songs in a Playlist

1. In the Library, tap or slide your finger on the bottom row to go to the Playlists category.
2. Tap a playlist to open it.
3. Tap the first song or any song in the playlist.

When you tap a song in the list to play it, the Now playing list is updated with the song list from your playlist.

Managing Your Playlists



After creating a playlist, you can add more songs to it, rearrange their order, and more.

To add songs to a playlist:

1. In the Library, tap or slide your finger on the bottom row to go to the Playlists category.
2. Tap a playlist to open it.
3. Press  and then tap **Add songs**.
4. Go to the Songs category or any other category.
5. Select the songs you want to add to the playlist and then tap **Add**.

Tip: While playing back a song, press  and then tap **Add to playlist** to add the current song to a playlist.

To rearrange the songs in a playlist:

1. In the Library, tap or slide your finger on the bottom row to go to the Playlists category.
2. Tap a playlist to open it.
3. Press  and then tap **Change order**.
4. Press and hold  at the end of the song title you want to move. When the row is highlighted, drag it to its new position, and then release.
5. Tap **Done**.

To delete a song in a playlist:





1. In the Library, tap or slide your finger on the bottom row to go to the Playlists category.
2. Tap a playlist to open it.
3. Press  and then tap **Remove songs**.
4. Select the songs you want to delete and then tap **Remove**.

To delete a playlist:

1. In the Library, tap or slide your finger on the bottom row to go to the Playlists category.
2. Press  and then tap **Delete playlists**.
3. Select the playlists to delete and then tap **Delete**.

Setting a Song as a Ring Tone

You can select a song from the Music application's Library and set it as your device's ring tone or a ring tone for a certain contact.

1. Press  and tap  > **Music**.
2. Tap  at the bottom-left corner of the screen to go to the Library.
3. In the Library, select the song that you want to use as ring tone and then play it back.
4. On the Playback screen, press  and then tap **Set as ringtone**.
5. In the **Set as ringtone** options menu, tap **Phone ringtone** or **Contact ringtone**.





Note: If you select **Contact ringtone**, you need to select the contacts you want to associate the song with in the next screen.

To confirm that a song was added as a ring tone:

1. From the Home screen, press  and then tap **Settings**.
2. On the Settings screen, tap **Sound & display** > **Phone ringtone**. The song should be listed as an option.

Sending Music Using Bluetooth

You can select a song from the Music application's Library and send it to someone's phone or your computer using Bluetooth.

1. Press  and tap  > **Music**.
2. Tap  at the bottom-left corner of the screen to go to the Library.
3. In the Library, select the song that you want to use as ring tone and then play it back.
4. On the Playback screen, press  and then tap **Share** > **Bluetooth**.

In the next few steps, you'll be asked to turn on Bluetooth on your device and connect to the receiving Bluetooth device so the files can be sent. For more information, see "Bluetooth" on page 94.

About the Music Widget

You can use the Music widget to play music right from your Home screen. To find out how you can add this widget to your Home screen, see "Customizing the Home Screen" on page 23.

Listening to the Radio

FM Radio lets you listen to FM radio stations on your phone. You will first need to connect a wired headset to the audio jack of your device to use FM Radio. FM Radio uses the stereo headset as the FM radio antenna.

Note: A wired headset is not included with your device. It must be purchased separately.



1. FM radio frequency
2. Drag to tune in to a frequency on the FM band.
3. Tap to fine tune the radio frequency by -0.1 MHz.
4. Tap to search the FM band for the previous FM station.
5. View the All presets list.
6. Tap to change the name of the current station you are tuned into.
7. Tap to search the FM band for the next FM station.
8. Tap to fine tune the radio frequency by +0.1 MHz.
9. Radio signal strength
10. Turn FM Radio off or on.

Listening to an FM Station



1. Press and then tap > **FM Radio**.

The first time you open FM Radio, it automatically scans for available FM stations, saves them as presets, and plays the first FM station found.



Note: To repeat scanning and saving of FM stations, press and then tap **Scan & Save**.

2. Press to stop the auto-scan.
3. On the FM Radio screen, you can:
 - Tap and then select a station you want to listen to.
 - Tap to go to the previous available FM station, or to go to the next available FM station.
 - Press the volume buttons on the side of the phone to adjust the volume.
 - Press to set more FM Radio options.

Adding Station Names

1. Press  and then tap  > **FM Radio**.
2. Tune in to the desired FM station, and then tap .
3. Enter a station name for the selected FM station, and then tap **Save**.

Minimizing or Turning Off FM Radio

- ▶ Do one of the following:
 - Press  to minimize and keep FM Radio running in the background so you can listen to the radio while going to another screen.
 - On the FM Radio screen, tap  on the upper-right corner of the FM Radio screen to turn off FM Radio.



21. Bluetooth

- ◆ Turning Bluetooth On or Off (page 94)
- ◆ Changing the Device Name (page 94)
- ◆ Connecting a Bluetooth Headset or Car Kit (page 94)
- ◆ Reconnecting a Headset or Car Kit (page 95)
- ◆ Disconnecting or Unpairing From a Bluetooth Device (page 95)
- ◆ Sending and Receiving Information Using Bluetooth (page 96)
- ◆ Adding the Bluetooth Received Folder to the Home Screen (page 98)

Using Bluetooth

Bluetooth is a short-range communications technology that allows you to connect wirelessly to a number of Bluetooth devices, such as headsets and hands-free car kits, and Bluetooth-enabled handhelds, computers, printers, and wireless phones. The Bluetooth communication range is usually up to approximately 30 feet.

Turning Bluetooth On or Off



1. Press  > , and then tap **Settings > Wireless & networks**.
2. Select or clear the **Bluetooth** check box.

An even easier way to turn Bluetooth on or off is with the Bluetooth widget on the Home screen. For instructions on adding a widget to the Home screen, see “Customizing the Home Screen” on page 23.

Note: Turn off Bluetooth when not in use to conserve battery power, or in places where using a wireless device is prohibited, such as aboard an aircraft and in hospitals.

Changing the Device Name

The device name identifies your device to other devices.

1. Press  > , and then tap **Settings > Wireless & networks**.
2. If the Bluetooth check box is not selected, select it to turn Bluetooth on.
3. Tap **Bluetooth settings > Device name**.
4. Enter the name for your device in the dialog box, and then tap **OK**.

Connecting a Bluetooth Headset or Car Kit

You can listen to music over an Bluetooth stereo headset, or have hands-free conversations using a compatible Bluetooth headset or car kit. It's the same procedure to set up stereo audio and hands-free devices.

For you to listen to music with your headset or car kit, the headset or car kit must support the A2DP Bluetooth profile.



1. Press  > , and then tap **Settings > Wireless & networks > Bluetooth settings**.
2. If Bluetooth is not switched on, tap the **Bluetooth** check box to switch it on.

3. Make sure that the headset is discoverable, so that your device can find the headset. Refer to the instructions that came with the headset to find out how to set it in discoverable mode.
4. Tap **Scan for devices**. Your device will start to scan for Bluetooth devices within range.
5. When you see the name of your headset displayed in the Bluetooth devices section, tap the name. Your device then automatically tries to pair with the headset.
6. If automatic pairing fails, enter the passcode supplied with your headset.

The pairing and connection status is displayed below the hands-free headset or car kit name in the Bluetooth devices section. When the Bluetooth headset or car kit is connected to your device, the Bluetooth connected icon  is displayed in the status bar. Depending on the type of headset or car kit you have connected, you can then start using the headset or car kit to listen to music or make and receive phone calls.

Reconnecting a Headset or Car Kit



When you have paired a headset with your device, you should be able to reconnect it automatically by turning on Bluetooth on your device, and then turning on the headset. However, sometimes you will need to reconnect manually, for example if you have been using your headset with another Bluetooth device.

1. Press  > , and then tap **Settings > Wireless & networks > Bluetooth settings**.
2. If Bluetooth is not switched on, tap the **Bluetooth** check box to switch it on.
3. Make sure that the headset is discoverable.
4. Tap the headset's name in the Bluetooth devices section.
5. If prompted to enter a passcode, try 0000 or 1234, or consult the headset/car kit documentation to find the passcode.

If you still cannot reconnect to the headset or car kit, follow the instructions in “Disconnecting or Unpairing From a Bluetooth Device” in this chapter, and then follow the instructions in “Connecting a Bluetooth Headset or Car Kit.”



Disconnecting or Unpairing From a Bluetooth Device

To disconnect a Bluetooth device:

1. Press  > , and then tap **Settings > Wireless & networks > Bluetooth settings**.
2. In the Bluetooth devices section, press and hold the device to disconnect.
3. Tap **Disconnect**.

To unpair from a Bluetooth device:

You can make your device forget its pairing connection with another Bluetooth device. To connect to the other device again, you may need to enter or confirm a passcode again.









1. Press  > , and then tap **Settings > Wireless & networks > Bluetooth settings**.
2. In the Bluetooth devices section, press and hold the device to unpair.
3. Tap **Unpair**.

Sending and Receiving Information Using Bluetooth

You can use Bluetooth to transfer information between your device and another Bluetooth-enabled device such as a phone or notebook computer. The first time you transfer information between your device and another device, you need to enter or confirm a security passcode. After that, your device and the other device are paired, and you will not need to exchange passcodes to transfer information in the future.

Sending Information From Your Device to Another Device

You can send the following types of information, depending on the device you are sending to:

- Images and videos
 - Calendar events
 - Contacts
 - Audio files
1. Set the receiving device to discoverable mode. You may also need to set it to “Receive Beams” or “Receive Files”. Refer to the device’s documentation for instructions on receiving information over Bluetooth.
 2. On the device, open the application that contains the information or file you want to send. For example, if you want to send a photo, press  and tap  > **Gallery**.
 3. Follow the steps for the type of item you want to send:
 - **Photo or video** (in Camera). After capturing a photo, on the preview screen, tap the Share button , and then tap **Bluetooth**.
 - **Photos and videos** (in Gallery). On the Albums tab , tap an album. Tap the Share button , tap Bluetooth, select the items you want to share, and then tap **Next**.
 - **Calendar event**. In the Calendar’s Day view, Agenda view, or Week view, press and hold the event, and then tap **Share vCalendar** > **Bluetooth**.
 - **Contact**. On the People screen’s All tab , press and hold the contact, and then tap **Send contact as vCard**. Tap the down arrow icon, and then select **Bluetooth** from the displayed list.
 - **Music track**. With the track displayed on the Now playing screen, press , and then tap **Share** > **Bluetooth**.
 - **Voice recording**. On the main Voice Recorder screen, tap the Share button , and then tap **Bluetooth**.
 4. If you are prompted to turn on Bluetooth, tap **Yes**.
 5. Tap the name of the receiving device.
 6. If prompted, accept the connection on the receiving device, and enter the same passcode on both your device and the other device, or confirm the auto-generated passcode.
 7. On the receiving device, accept the file.



The location where the information is saved depends on the type of information and the receiving device:

- If you send a calendar event or contact, it is normally added directly to the corresponding application on the receiving device. For example, if you send a calendar event to a compatible phone, the event is shown in that phone’s calendar application.
- If you send another file type to a Windows computer, it is normally saved in the Bluetooth Exchange folder within your personal document folders.
 - On Windows XP, the path may be: C:\Documents and Settings\[your username]\My Documents\Bluetooth Exchange.
 - On Windows Vista, the path may be: C:\Users\[your username]\Documents.
- If you send a file to another device, the saved location may depend on the file type. For example, if you send an image file to another wireless phone, it may be saved in a folder named “Images.”

Receiving Information From Another Device

Your device is capable of receiving a wide variety of file types with Bluetooth, including photos, music tracks, and documents such as PDFs.

To receive files from another device, you need to have a microSD card installed in your device.

1. Press  > , and then tap **Settings > Wireless & networks > Bluetooth settings**.
2. If Bluetooth is not switched on, tap the **Bluetooth** check box to switch it on.
3. Tap the **Discoverable** check box.
4. On the sending device, send one or more files to your device. Refer to the device's documentation for instructions on sending information over Bluetooth.
5. If prompted, enter the same passcode on both your device and the other device, or confirm the auto-generated passcode. A Bluetooth authorization request is displayed on your device.
6. If you want to automatically receive files from the sending device in future, select the **Always trust device** check box.
7. Tap **OK**.
8. When your device receives a file transfer request notification, slide down the notifications panel, and then tap **Accept**.
9. When a file is transferred, a notification is displayed. To open the file immediately, slide down the notifications panel, and then tap the relevant notification.

When you open a received file, what happens next depends on the file type:



- Media files and documents are usually opened directly in a compatible application. For example, if you open a music track, it starts playing in the Music application.
- For a vCalendar file, select the calendar where you want to save the event, and then tap **Import**. The vCalendar is added to your Calendar events. For more information on using Calendar, see "Calendar" on page 54.
- For a vCard contact file, if there are multiple vCard files on your storage card, you can choose to import one, several, or all of those contacts to your contacts list.

Using Bluetooth FTP Server

Bluetooth FTP Server allows other devices with Bluetooth FTP profile to view, access, copy, and delete files from your device's microSD card.

Note: To use Bluetooth FTP Server, you need to have a microSD card installed in your device.



To turn Bluetooth FTP Server on and allow access to the microSD card contents:

1. Press  > , and then tap **Settings > Wireless & networks > Bluetooth settings > Advanced Settings**.
2. Select the **FTP Server** check box.
3. Pair your device with the other Bluetooth device that wants to access the microSD card contents. For more information about Bluetooth pairing, see "Connecting a Bluetooth Headset or Car Kit."
4. When the other device attempts to access your device's microSD card, a Bluetooth Authorization Request appears on the screen. Tap **Accept**. If you want to allow the connecting device to always access your device's microSD card, select the **Always** check box before you tap **Accept**.

The microSD card contents appear on the other device's screen.

Adding the Bluetooth Received Folder to the Home Screen

You can add a folder to the Home screen that shows all files you have received with Bluetooth.

1. Press  and tap .
2. On the Add to Home screen, tap **Folder > Bluetooth Received**.
3. Press and hold the Bluetooth received folder icon, and drag it to the Home screen position you want.
4. To view the folder contents, tap the folder icon. To open a file, tap the file name.

Section 3
Sprint Service





3A. Sprint Service: The Basics

- ◆ Voicemail (page 100)
- ◆ Text Messaging (SMS) and Multimedia Messaging (MMS) (page 102)
- ◆ Caller ID (page 108)
- ◆ Call Waiting (page 108)
- ◆ Making a 3-Way Call (page 108)
- ◆ Call Forwarding (page 108)
- ◆ Roaming (page 109)

Voicemail

Setting Up Your Voicemail

Your device automatically transfers all unanswered calls to your voicemail, even if your device is in use or turned off. You should set up your Sprint Voicemail and personal greeting as soon as your device is activated.

1. Press  and tap  > **Voicemail**.
2. In the Personalize your Voicemail window, tap **Personalize now**.
3. Your device will automatically connect with Sprint Voicemail service. Follow the voice prompts to:
 - Create your passcode.
 - Record your name announcement.
 - Record your greeting.

Note: Voicemail Passcode

Sprint strongly recommends that you create a passcode when setting up your voicemail to protect against unauthorized access. Without a passcode, anyone who has access to your handset is able to access your voicemail messages.

Voicemail Notification

There are several ways your device alerts you to a new message:

- By sounding the assigned ringer type.
- By displaying  at the top of your screen.
- By flashing the notification LED (if enabled).

New Voicemail Message Alerts

When you receive a new voice message, you will see a message in the Notification panel (see “Notifications Panel” on page 11).

Note: When you are roaming off the Nationwide Sprint Network, you may not receive notification of new voicemail messages. Sprint recommends that you periodically check your voicemail by dialing 1 + area code + your wireless phone number. When your voicemail answers, press  and enter your passcode. Roaming rates apply when you access voicemail while roaming off the Nationwide Sprint Network.

Your device accepts messages even when it is turned off. However, your device notifies you of new messages only when it is turned on and you are in a Sprint service area.

Retrieving Your Voicemail Messages

You can review your messages directly from your wireless device or from any other touch-tone phone.

Using Your Device

1. Press  and tap  > **Voicemail**.
2. Tap on a message to play it back.

Using Another Phone to Access Messages

1. Dial your wireless phone number.
2. When your voicemail answers, tap .
3. Enter your passcode.

Tip: When you call voicemail from another phone, you first hear the header information (date, time, and sender information) for the message. To skip directly to the message, tap  during the header.

Clearing the Message Icon

Your device may temporarily continue to display the message icon after you have checked your voice and text messages.

- ▶ Open the Notifications panel (see “Notifications Panel” on page 11) and tap **Clear notifications**.

Voicemail Key Guide

Here’s a quick guide to your keypad functions while listening to voicemail messages.

 Date/Time	 Send Reply	 Advance
 Replay	 Rewind	 Forward
 Erase	 Return Call	 Save
 Cancel	 Help	 Skip

Text Messaging (SMS) and Multimedia Messaging (MMS)



With Text Messaging (SMS), you can send and receive instant text messages between your wireless device and another messaging-ready phone.

In addition, Text Messaging includes a variety of preset messages, such as “I’m running late, I’m on my way,” that make composing messages fast and easy. Use your device to customize your own preset messages (up to 160 characters).

Multimedia messages, or MMS, can contain text and pictures, recorded voice, audio or video files, picture slideshows, contact cards (vCard), or appointments (vCalendar).

Note: See your service plan for applicable charges for Text Messaging and SMS Voice Messaging.

Composing Text Messages

1. Press  and tap  > **Messages**.
2. On the All messages screen, tap **New message**. The Compose screen opens.
3. Fill in one or more recipients. You can:
 - Enter phone numbers directly in the **To** field. If you’re sending the message to several phone numbers, separate the phone numbers with a comma. As you enter information, any matching phone numbers from your contacts list are displayed. Tap a match to enter that number or address directly.
 - Tap the  icon, and then select the phone numbers of the contacts to whom you want to send the message. You can also select contact groups as recipients. When you have selected all the message recipients, tap **Done**.
4. Tap the “Tap to compose” text box and then start composing your message.

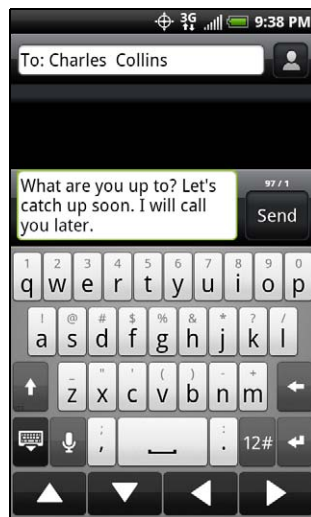

Note: A counter appears at the top of the **Send** button to tell you how many characters you have entered and how many characters are left. Once you go over the 160-character limit, a new message is created but automatically joined into one when received.







Tap the navigation buttons at the bottom of the onscreen keyboard to navigate between text fields.

5. When done, tap **Send** to send the text message.





Preset Messages

Preset messages make it easy to compose text messages.

To add or edit preset messages:

1. Press  and tap  > **Messages**.
2. On the All messages screen, tap **New message**. The Compose screen opens.
3. Fill in one or more recipients. You can:
 - Enter phone numbers directly in the **To** field. If you're sending the message to several phone numbers, separate the phone numbers with a comma. As you enter information, any matching phone numbers from your contacts list are displayed. Tap a match to enter that number or address directly.
 - Tap the  icon, and then select the phone numbers of the contacts to whom you want to send the message. You can also select contact groups as recipients. When you have selected all the message recipients, tap **Done**.
4. Tap the "Tap to compose" text box, press  and tap **Quick text**. (You will see the list of preset messages.)
5. To add a new message, press  and tap **Insert**. Enter your message and tap **OK**.
– or –
To edit a preset message, press  and tap **Edit**. Tap the message you want to edit, edit the message, and then tap **OK**.

Sending a Multimedia Message (MMS)

1. Press  and tap  > **Messages**.
 2. On the All messages screen, tap **New message**. The Compose screen opens.
 3. Fill in one or more recipients. You can:
 - Enter phone numbers or email addresses directly in the **To** field. If you're sending the message to several recipients, separate the phone numbers or email addresses with a comma. As you enter information, any matching phone numbers or addresses from your contacts list are displayed. Tap a match to enter that number or address directly.
 - Tap the  icon, and then select the contacts to whom you want to send the message. You can also select contact groups as recipients. When you have selected all the message recipients, tap **Done**.
- Note:** You can add a subject line by pressing  and then tapping **Add subject**.
4. Tap the text box that contains the text "Tap to compose", and then start composing your message.
 5. Press  and then tap **Attach**.
 6. On the Attach window, select from the following file attachments:
 - **Picture**. Select **Camera** to take a photo and attach it, or **Pictures** to attach a photo from your storage card.
 - **Video**. Select **Camcorder** to capture a video and attach it, or **Videos** to attach a video from your storage card.
 - **Audio**. Select **Voice Recorder** to make a voice recording and attach it, or **Music & sounds** to attach a music file or voice recording from your storage card.
 - **Location**. You can attach location information. Send your current location (requires GPS to be turned on), a location stored in Footprints, or a location you pick on a map. For more information about GPS, maps, and Footprints, see "GPS Navigation" on page 155.
 - **Contact (vCard)**. Select a contact from your phone, and then select which contact information you want to attach.
 - **Appointment (vCalendar)**. Select the calendar event you want to attach.

- **Slideshow.** Opens the Edit slideshow screen. Tap **Add slide** to create a new slide. Tap the created slide (for example, Slide 1), tap **Insert picture**, and then select the picture you want to add to the slide. You can also navigate to the text box and enter a caption for the picture. When finished, tap **Done** to attach the slideshow to your message.

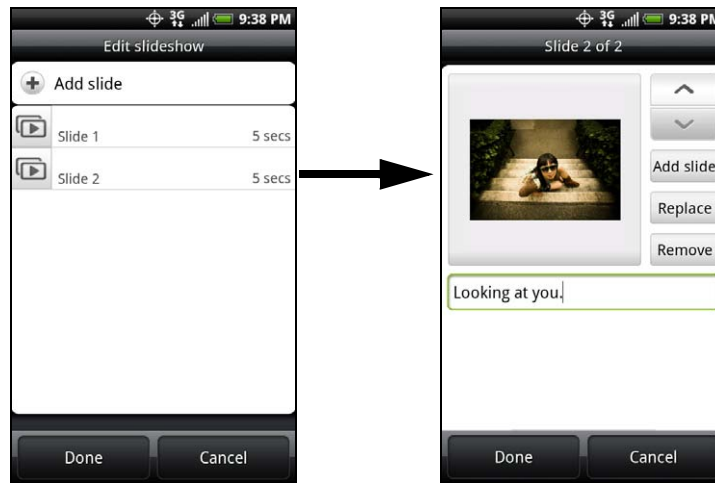

Tip: When editing multiple slides, tap to edit the next slide or tap to return to the previous slide.

While editing the slideshow, press to let you preview the slideshow, add music or video to a slide, remove a slide, and more.

7. When you have finished composing the multimedia message, tap **Send**.

Saving and Resuming a Draft Message

While composing a text or multimedia message, press to automatically save your message as a draft.

To resume composing the message:

1. On the All messages screen, press , and then tap **Drafts**.
2. Tap the message to resume editing it.
3. When you finish editing the message, tap **Send**.

New Messages Notification

Depending on your notification settings, the device will play a ring tone, vibrate, or display the message briefly in the status bar when you receive a new text or multimedia message. To change the notification for new text and multimedia messages, see “Setting Text and Multimedia Message Options” for details.



A new message icon () also appears in the notifications area of the status bar to notify you of a new text or multimedia message. The Messages application icon (if shown on the Home screen) also displays the number of new messages

To open the message, press and hold the status bar, and then slide the status bar down to open the Notifications panel. Tap the new message to open and read it. For information on reading and replying to messages see “Managing Message Conversations” in this chapter.

Managing Message Conversations

Text and multimedia messages that are sent to and received from a contact (or a number) are grouped into conversations or message threads in the All messages screen. Threaded text or multimedia messages let you see exchanged messages (similar to a chat program) with a contact on the screen.

To read a text message:

Do one of the following:

- On the All messages screen, tap the text message or message thread to open and read it.
- If you have a new message notification, press and hold the status bar, and then slide the status bar down to open the Notifications panel. Tap the new message to open and read it.



To return to the All messages screen from a text message thread, press  and then tap **All messages**.

Note: To view the details of a particular message, in the message thread, press and hold the message to open the options menu, and then tap **View message details**.

If a message contains a link to a Web page, tap the message and then tap the link to open it in the Web browser.

If a message contains a phone number, tap the message and then tap the phone number to dial the number or add it to your contacts.



Viewing a multimedia message (MMS):

1. Press  and tap  > **Messages**.
2. On the All messages screen, tap a multimedia message or message thread to open it.
3. Tap the attachment to open it. If the attachment is a vCard contact, it is imported to your device's contacts list. For more information, see “People” on page 41. If the attachment is a vCalendar file, you can choose the calendar where you want to save the event. For information on using Calendar, see “Calendar” on page 54.
4. To save the attachment to the storage card, press and hold the sender's name or number, and then tap **Save [attachment type]** on the options menu.

Note: When **Auto-retrieve** in MMS settings is disabled, only the message header is downloaded. To download the entire message, tap the **Download** button at the right side of the message. For details, see “Setting Text and Multimedia Message Options” later in this chapter.

If you are concerned about the size of your data downloads, check the multimedia message size before you download it.



To reply to a text or multimedia message:

1. Press  and tap  > **Messages**.
2. On the All messages screen, tap a text or multimedia message thread to open it.
3. Tap the text box at the bottom of the screen, enter your reply message, and then tap **Send**.



Note: To reply to a text message with a multimedia message, open the text message, press  and then tap **More > Add subject**, or **Attach**. The text message is automatically converted into a multimedia message.

To protect a message from deletion:



You can lock a message so that it will not be deleted even if you delete the other messages in the conversation.

1. Press  and tap  > **Messages**.
2. On the All messages screen, tap a message thread.
3. Press and hold the message that you want to lock
4. Tap **Lock message** on the options menu.
A lock icon  is displayed at the right hand side of the message.

To delete a message thread:

1. Press  and tap  > **Messages**.
2. On the All messages screen, tap the message thread that you want to delete.
3. Press , and then tap **Delete**.
4. When prompted to confirm, tap **OK**.
Any locked messages in the thread will not be deleted unless you select the **Delete locked messages** check box.

To delete several message threads:

1. Press  and tap  > **Messages**.
2. On the All messages screen, press , and then tap **Delete**.
3. Select the message threads you want to delete.
4. Tap **Delete**. Any locked messages will not be deleted.



To delete a single message:

1. While viewing a message thread, press and hold the message that you want to delete.
2. If the message is locked, tap **Unlock message** on the options menu, and then press and hold the message to display the options menu again.
3. Tap **Delete message** on the options menu.
4. When prompted to confirm, tap **OK**.

To view contact details and communicate with a contact:

When you have received a message from someone in your stored contacts, you can tap the contact's photo or icon in the message thread to open a menu of options. Depending on the stored contact information, you can view the contact details, phone or send an email message to the contact, and more.

Setting Text and Multimedia Message Options

Press  and tap  > **Messages**. On the All messages screen, press  and then tap **Settings** to set the text or multimedia message options. You can set the following:

SMS settings

- **Priority setting:** Set the message priority of text messages sent.

MMS settings

- **Auto-retrieve:** Select this option to automatically retrieve all your multimedia messages completely. When selected, the multimedia message header plus the message body and attachments will automatically download to your device. If you clear this check box, only the multimedia message header will be retrieved and shown in your All messages screen.
- **Priority setting:** Set the message priority of text messages sent.
- **Maximum message size:** Set the maximum file size of a multimedia message. The multimedia message will not be sent out if it exceeds the file size set here.
- **Connection settings:** View various MMS connection settings such as the MMS connection name and server address.

Received messages

- **Received notification:** Select this option if you want to receive a notification in the status bar when a new text or multimedia message arrives.
- **Play notification sound:** If you want the device to ring when a new message arrives, select this option.
- **Notification sound:** Select a ring tone that is specific to new text and multimedia messages. Note that the ring tone briefly plays when selected.
- **Vibrate:** Select this option if you want the device to vibrate when a new text or multimedia message arrives.

Sent messages







- **Sent notification:** Select this option if you want to receive a notification in the status bar when a message is sent successfully.
- **Failure notification:** Select this option if you want to receive a notification in the status bar when a message is not sent successfully.
- **Play notification sound:** If you want the device to ring when a sent or failure notification is received, select this option.
- **Notification sound:** Select a ring tone that is specific to sent or failure notifications. Note that the ring tone briefly plays when selected.
- **Vibrate:** Select this option if you want the device to vibrate when a new text or multimedia message arrives.

Adding the Messages Widget

Add the Messages widget to let you read your messages on the Home screen. To learn how to add widgets, refer to “Customizing the Home Screen” on page 23.

Caller ID

Caller ID allows people to identify a caller before answering the device by displaying the number of the incoming call. If you do not want your number displayed when you make a call, follow these steps.

1. Press  and tap .
2. Tap   .
3. Enter a phone number.
4. Tap .

To permanently block your number, call Sprint Customer Service.

Call Waiting



When you're on a call, Call Waiting alerts you to incoming calls by sounding two beeps. Your device's screen informs you that another call is coming in and displays the caller's phone number (if it is available and you are in digital mode).

To respond to an incoming call while you're on a call:

- ▶ Press  and then tap **Flash**. (This puts the first caller on hold and answers the second call.)



To switch back to the first caller:

- ▶ Press  and then tap **Flash** again.

Tip: For those calls where you don't want to be interrupted, you can temporarily disable Call Waiting by pressing    before placing your call. Call Waiting is automatically reactivated once you end the call.

Making a 3-Way Call

With 3-Way Calling, you can talk to two people at the same time. When using this feature, the normal airtime rates will be charged for each of the two calls.

1. On the Phone screen, enter a number and tap .
2. Once you have established the connection, press , tap **Add call**, and dial the number of the second participant. (This puts the first caller on hold and dials the second number.)
3. When you're connected to the second party, press  and tap **Merge calls**.

If one of the people you called hangs up during your call, you and the remaining caller stay connected. If you initiated the call and are the first to hang up, all callers are disconnected.





To end the three-way call, tap .

Call Forwarding







Call Forwarding lets you forward all your incoming calls to another phone number – even when your device is turned off. You can continue to make calls from your device when you have activated Call Forwarding.

To activate Call Forwarding:

1. Press  and tap .

2. Tap   .
3. Enter the area code and phone number to which you want your calls forwarded.
4. Tap . (You will see a message and hear a tone to confirm the activation of Call Forwarding.)

To deactivate Call Forwarding:

1. Press  and tap .
2. Tap    .
3. Tap . (You will see a message and hear a tone to confirm the deactivation.)

Note: You are charged a higher rate for calls you have forwarded.

Roaming

Roaming Icon

Your display screen always lets you know when you're off the Nationwide Sprint Network. Anytime you are roaming, the device displays the roaming icon ().

Tip: Remember, when you are using your device off the Nationwide Sprint Network, always dial numbers using 11 digits (1 + area code + number).

Roaming on Other Digital Networks

When you're roaming on digital networks, your call quality and security will be similar to the quality you receive when making calls on the Nationwide Sprint Network. However, you may not be able to access certain features, such as data services, depending on the available network.

Note: If you're on a call when you leave the Nationwide Sprint Network, your call is dropped. If your call is dropped in an area where you think Sprint service is available, turn your device off and on again to reconnect to the network.

Checking for Voicemail Messages While Roaming

When you are roaming off the Nationwide Sprint Network, you may not receive on-device notification of new voicemail messages. Callers can still leave messages, but you will need to periodically check your voicemail for new messages if you are in a roaming service area for an extended period of time.



1. Dial 1 + area code + your phone number.
2. When you hear your voicemail greeting, tap .
3. Enter your passcode at the prompt and follow the voice prompts.

When you return to the Nationwide Sprint Network, voicemail notification will resume as normal.

Setting Roam Mode

Your device allows you to control your roaming capabilities. By using the Roaming menu option, you can determine which signals your device accepts.



Choose from two different settings on your dual-band phone to control your roaming experience.

1. Press  >  > **Settings > Wireless & networks > Mobile networks.**
2. Tap **Roaming.**
 - **Sprint Only** to access only the Sprint network and prevent roaming on other networks.
 - **Automatic** to seek service on the Nationwide Sprint Network. When Sprint service is unavailable, the device searches for an alternate system.

Call Guard

Your device has two ways of alerting you when you are roaming off the Nationwide Sprint Network: the onscreen roaming icon and Call Guard. Call Guard makes it easy to manage your roaming by requiring an extra step before you can place or answer a roaming call. (This additional step is not required when you make or receive calls while on the Nationwide Sprint Network.)

To turn Call Guard on or off:

1. Press  >  > **Settings > Wireless & networks > Mobile networks.**
2. Select the **Call guard** check box to turn on Call Guard; clear the check box to turn off Call guard.

Note: Your device's Call Guard is turned off by default.

Voice dialing and speed dialing are not available when you are roaming with Call Guard enabled.

To place roaming calls with Call Guard on:

1. On the Phone screen, dial 1 + area code + the seven-digit number and tap  .
2. Select **Roam Call**.

To answer incoming roaming calls with Call Guard on:

- ▶ Tap **Answer**. (A message will be displayed notifying you that roaming charges will apply.)



Note: If the **Call Guard** check box is selected, you need to take extra steps to make and receive roaming calls.

Data Roam Guard

Depending on service availability and roaming agreements, your device may be able to access data services while roaming on certain digital systems. You can set your device to alert you when you are roaming off the Nationwide Sprint Network and try to use data services such as messaging.

Note: Your device's **Data Roam Guard** is turned off by default.

To set your Data Roam Guard notification:

1. Press  >  > **Settings > Wireless & networks > Mobile networks.**
2. Tap **Data Roam Guard**.
 - **Default** enables data roaming internationally. The Data Roam Guard may display a confirmation message and alert.
 - **Always ask** sets your device's Data Roam Guard feature on. You will see a prompt and will be required to respond anytime you access data services while roaming.
 - **Never ask** turns your device's Data Roam Guard feature off. You will not be notified of your roaming status when accessing data services.

To use data services when Data Roam Guard is active:

- ▶ When a pop-up notification appears informing you that data roam charges may apply, tap **Roam** to connect.

3B. Web and Data Services

- ◆ Ways of Connecting to the Internet (page 111)
- ◆ Connecting Using Wi-Fi (page 111)
- ◆ Connecting Using Sprint 4G (page 113)
- ◆ Getting Started With Data Services (page 114)
- ◆ Connecting to a Virtual Private Network (VPN) (page 115)
- ◆ Using the Device's Web Browser (page 116)
- ◆ Accessing Email Messages (page 122)
- ◆ Google Talk (page 131)
- ◆ Downloading Applications and Games From Android Market (page 136)
- ◆ Peep (page 138)
- ◆ Stocks (page 140)
- ◆ Weather (page 141)
- ◆ News Feeds (page 143)
- ◆ Sprint Mobile Hotspot (page 145)
- ◆ Using Your Device as a Modem (Internet Sharing) (page 147)
- ◆ Data Services FAQs (page 147)

Ways of Connecting to the Internet

Your device's networking capabilities allow you to wirelessly access the Internet or your corporate network through one of the following connections:



- Wi-Fi (See "Connecting Using Wi-Fi" for details.)
- Sprint 4G (See "Connecting Using Sprint 4G" for details.)
- Data Services (See "Getting Started With Data Services" for details.)
- Virtual Private Networks or VPN (See "Connecting to a Virtual Private Network (VPN)" for details.)

Connecting Using Wi-Fi



Wi-Fi provides wireless Internet access over distances of up to 300 feet. To use your device's Wi-Fi, you need access to a wireless access point or "hotspot".

Note: The availability and range of the Wi-Fi signal depends on the number, infrastructure, and other objects through which the signal passes.

Turning Wi-Fi On and Connecting to a Wireless Network

1. Press  >  and tap **Settings > Wireless & networks**.
2. Select the **Wi-Fi** check box to turn Wi-Fi on. The device will scan for available wireless networks.
3. Tap **Wi-Fi settings**. The network names and security settings (Open network or Secured with WEP) of detected Wi-Fi networks are displayed in the Wi-Fi networks section.
4. Tap a Wi-Fi network to connect. If you selected an open network, you will be automatically connected to the network. If you selected a network that is secured with WEP, enter the key, and tap **Connect**.



Depending on the network type and its security settings, you may also need to enter more information or choose a security certificate.

When your device is connected to a wireless network, the Wi-Fi icon () appears in the status bar and tells you the approximate signal strength (number of bands that light up). If **Network notification** in Wi-Fi settings is enabled, this icon () appears in the status bar whenever the device detects an available wireless network within range.

Note: The next time your device connects to a previously accessed secured wireless network, you will not be prompted to enter the WEP key again, unless you reset your device to its factory default settings.

Wi-Fi networks are self-discoverable, which means no additional steps are required for your device to connect to a Wi-Fi network. It may be necessary to provide a username and password for certain closed wireless networks.

Checking the Wireless Network Status

1. Press  >  and tap **Settings > Wireless & networks**.
2. On the Wireless & networks screen, tap **Wi-Fi settings**, and then tap the wireless network that the device is currently connected to.

A message box is then displayed showing the Wi-Fi network name, status, speed, signal strength, and more.



Note: If you want to remove the device's wireless network settings, tap **Forget** on this window. You need to enter the settings again if you want to connect to this wireless network.

Connecting to Another Wi-Fi Network

1. On the Wireless controls screen, tap **Wi-Fi settings**. Detected Wi-Fi networks are displayed in the Wi-Fi networks section. To manually scan for available Wi-Fi networks, on the Wi-Fi settings screen, press  and tap **Scan**.
2. Tap another Wi-Fi network to connect to it.

Note: If the wireless network you want to connect to is not in the list of detected networks, scroll down the screen, and tap **Add Wi-Fi network**. Enter the wireless network settings and tap **Save**.

Adding the Wi-Fi Widget

Add the Wi-Fi widget to the Home screen to make it faster for you to turn Wi-Fi on or off.

To learn how to add widgets, see "Customizing the Home Screen" on page 23.



Connecting Using Sprint 4G



Sprint 4G – a Mobile WiMAX (Worldwide Interoperability for Microwave Access) technology – provides your device with wireless Internet access over greater distances than Wi-Fi and delivers data transfer rates of up to 30 Mbps. To connect your device to Sprint 4G network, you need access to a Sprint 4G base station.

For more information about the availability of Sprint 4G in your location, visit www.sprint.com/coverage on the Web.

Note: The availability and range of the Sprint 4G depends on a number of factors including your distance to the Sprint 4G base station, and infrastructure and other objects through which the signal passes.



Turning Sprint 4G On and Connecting to the Sprint 4G Network

1. Press  >  and tap **Settings > Wireless & networks**.
2. Scroll down the screen and select the **4G** check box to turn Sprint 4G on. The device will automatically scan for the Sprint 4G network and will automatically connect to it.

When your device is connected to the Sprint 4G network, the 4G icon () appears in the status bar and tells you the approximate signal strength (number of bands that light up). If **Network notification** in 4G settings is enabled, this icon () appears in the status bar whenever the device detects the Sprint 4G network.

Note: The Sprint 4G network is self-discoverable, which means no additional steps are required for your device to connect to it.

Checking the Sprint 4G Network Status

1. Press  >  and tap **Settings > Wireless & networks**.
2. Scroll down the screen and tap **4G settings**. The network provider name, signal strength, and IP address are displayed.

Adding the Sprint 4G Widget

Add the Sprint 4G widget to the Home screen to make it faster for you to turn it on or off.

To learn how to add widgets, see “Customizing the Home Screen” on page 23.

Getting Started With Data Services

With your Sprint service, you are ready to start enjoying the advantages of data services. This section will help you learn the basics of using your data services, including managing your user name, launching a data connection, and navigating the Web with your device.

Your User Name

When you buy your device and sign up for service, you're automatically assigned a user name, which is typically based on your name and a number, followed by "@sprintpcs.com." (For example, the third John Smith to sign up for Sprint data services might have jsmith003@sprintpcs.com as his user name.)

When you use Sprint data services, your user name is submitted to identify you to the Nationwide Sprint Network. Your user name will be automatically programmed into your device. You don't have to enter it.

Finding Your User Name

If you aren't sure what your user name is, you can easily find it on your device.

- ▶ Press  > , tap **Settings > About phone > Network > Current username**.

Updating Your User Name

If you choose to change your user name and select a new one online, you must then update the user name on your device.

- ▶ Press  >  and tap **Settings > System updates > Update profile**. (To cancel, press  before completing the update.)

Launching a Web Connection

- ▶ Press  and tap  > **Internet**
(Your data connection starts and you see the SprintWebSM home page.)

Data Connection Status and Indicators

Your device displays the current status of your data connection through indicators at the top of the screen. The following symbols are used:



Your device is connected to the high-speed Sprint 3G network (EVDO). When the arrows are white, your device is transferring data (for example, when you are opening a Web page); when the triangles are gray, your device is connected to the network but is not currently transferring data (for example, when you are viewing a Web page that is completely open). In either state, you can receive incoming calls.





Your device is on and is connected to the Sprint 1xRTT data network. When the arrows are white, your device is transferring data (for example, when you are opening a Web page) and you cannot receive calls. When the arrows are gray, your device is connected to the network but is not currently transferring data (for example, when you are viewing a Web page that is completely open), and you can receive calls.

If you do not see an indicator, your device does not have a current data connection. To launch a connection, see "Launching a Web Connection."

Turning the Data Connection On or Off

Turning your data connection off can help optimize your battery life. It can also save money on data charges. However, when your data connection is turned off, you may not always receive automatic updates to your email, social network accounts, and other synchronized information.

1. Press  >  and then tap **Settings > Wireless & networks**.
2. Select the **Mobile network** check box to turn on the data connection; clear the check box to turn off the data connection.

Adding the Data Connection Widget

Add the Data connection widget to the Home screen to make it faster for you to turn the device's data connection on or off.

To learn how to add widgets, see “Customizing the Home Screen” on page 23.

Connecting to a Virtual Private Network (VPN)

From your device, you can add, set up, and manage virtual private networks (VPNs) that allow you to connect and access resources inside a secured local network, such as your corporate network.



Preparing Your Device for VPN Connection

Depending on the type of VPN you are using at work, you may be required to enter your login credentials or install security certificates before you can connect to your company's local network. You can get this information from your network administrator.

Also, your device must first establish a Wi-Fi or data connection before you can initiate a VPN connection. For information about setting up and using these connections on your device, see “Launching a Web Connection” and “Turning Wi-Fi On and Connecting to a Wireless Network.”



Setting Up Secure Credential Storage

If your network administrator instructs you to download and install security certificates, you must first set up the device's secure credential storage.

1. Press  > , tap **Settings > Security**, and then tap **Set password**.
2. Enter a new password (at least 8 characters without any spaces) for the credential storage, scroll down and confirm the password, and then tap **OK**.
3. Select the **Use secure credentials** check box.



You can then download and install the certificates needed to access your local network. Your network administrator can tell you how to do this.

Adding a VPN Connection

1. Press  >  and then tap **Settings > Wireless & networks > VPN settings**.
2. Tap **Add VPN**, and then tap the type of VPN you want to add.
3. Tap **VPN settings** and set them up according to the security details you have obtained from your network administrator.
4. When finished, press , and then tap **Save**.

The VPN is then added to the VPNs section of the VPN settings screen.

Connecting to a VPN

1. Press  >  and then tap **Settings > Wireless & networks > VPN settings**.
2. In the VPNs section, tap the VPN that you want to connect to.
3. When prompted, enter your log in credentials, and then tap **Connect**. When you are connected, the VPN connected icon  appears in the notification area of the title bar.
4. Open the Web browser to access resources such as intranet sites on your corporate network. For more information, see “Opening the Browser.”

Disconnecting From a VPN

1. Press and hold the title bar, and then slide down your finger to open the Notifications panel.
2. Tap the VPN connection to return to the VPN settings screen, and then tap the VPN connection to disconnect from it.

When your device has disconnected from the VPN, the VPN disconnected icon  is displayed in the notification area of the title bar.

Using the Device's Web Browser

Open the browser to start surfing the Web. The browser is fully optimized and comes with advanced features that let you enjoy Internet browsing on your device.

Opening the Browser

▶ Press  and tap  > **Internet**

The Browser Menu

Although the home page offers a broad and convenient array of sites and services for you to browse, not all sites are represented, and certain functions, such as going directly to specific websites, are not available. For these and other functions, you will need to use the browser menu. The browser menu offers additional options to expand your use of the Web on your device.

Opening the Browser Menu

The browser menu may be opened anytime you have an active data session, from any page you are viewing.

To open the browser menu:



▶ Press  while on the browser. (You will see the browser menu.)

Options available under the browser menu include:

- **Back:** Returns you to a previously viewed page (after having tapped **Forward**).
- **Forward:** Returns you to a previously viewed page (after having tapped **Back**).
- **Add bookmark:** Allows you to bookmark the current site.
- **Bookmarks:** Allows you to access and manage your bookmarks.
- **Windows:** Allows you to open additional browser windows.
- **More**
 - **Home:** Lets you return to your home page.
 - **Find on page:** Allows you to find specific text on a Web page.

- **Text selection:** Allows you to select text to copy, looking up for information, and share. For more information, see “Copying Text, Looking Up Information, and Sharing.”
- **Page info.** Lets you display the information about the website.
- **Share page.** Lets you send the website URL using Facebook, Friend Stream, email, MMS, or Peep.
- **Downloads.** Lets you view applications that you have downloaded from the Web.
- **History.** Keeps a list of links to your most recently visited sites. To navigate to a site, touch a site.
- **Settings.** Opens the browser settings.

Going to a Website



1. On the browser screen, press  and tap the URL box at the top of the screen.
2. Enter the website address using the keyboard. As you enter the address, matching website addresses will appear on the screen. Tap an address to go directly to that website or continue entering the website address.
3. Tap  on the onscreen keyboard.

Setting Your Home Page

1. With the browser open, press , and then tap **More > Settings > Set home page**.
2. In the Set home page screen, select the home page you want to use.
 - **Use default** to set the SprintWebSM home page as your home page.
 - **Use current** to set the current Web page you are browsing as your home page.
 - **Set home page** to enter the URL of the website you want to use as your home page.

Changing the Screen Orientation

The device automatically changes the screen orientation depending on how you are holding your device.

Note: The **Orientation** check box in  >  > **Settings > Sound & display** needs to be selected for the screen orientation to automatically change.

Browsing Full Versions (not Mobile Version) of Web Pages

Some websites display a mobile version of their pages to phone Web browsers. You can choose to view the full version of all pages, even for these sites.

- ▶ On the browser screen, press , tap **More > Settings**, and clear the **Mobile view** check box.

Navigating on a Web Page

Panning on a Web Page

- ▶ Slide your finger on the screen in any direction to navigate and view other areas of the Web page.

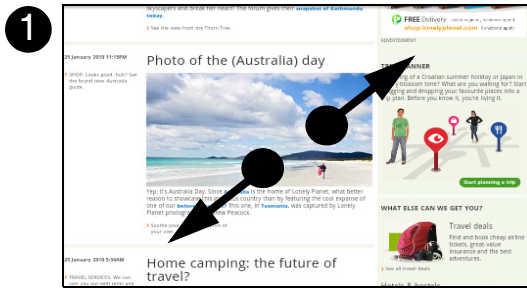

Zooming In or Out on a Web Page

- ▶ Tap the screen twice quickly to zoom in; tap the screen twice quickly again to zoom out.
 - or –
 - Pinch or spread the screen to zoom in and out.



Opening a New Browser Window

Open multiple browser windows to make it easier for you to switch from one website to another. You can open up to four browser windows.

1. On the browser screen, press  and then tap **Windows**.
2. Tap . A new browser window opens and goes to the home page that is set.

Switching Between Browser Windows

1. On the browser screen, press  and then tap **Windows**.
2. Select the browser window you want to view by sliding your finger on the screen from right to left.

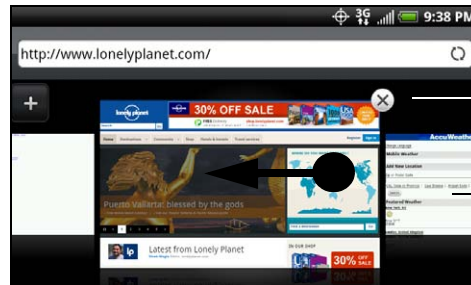

Tap to close the Web page.

Tap to display the Web page in full screen.

3. Tap the browser window to open it in full-screen mode.

Finding Text In a Web Page

1. While viewing a Web page, press  and tap **More > Find on page**.
2. Enter the search item. As you enter characters, matching characters will be highlighted in green. Tap the left or right arrow to go to the previous or next matching item.

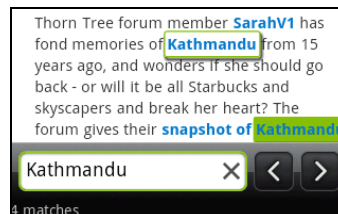

Selecting Links in Web Pages

Links can be selected as shown below. Links are enclosed in a colored box when selected.

Link	What to do
Web page address (URLs)	<ul style="list-style-type: none">● Tap the link to open the Web page.● Press and hold the link to open a menu that allows you to open, bookmark, copy to the clipboard, or share the link using email.
Email address	<ul style="list-style-type: none">● Tap to send an email message to the email address.● Press and hold and tap Copy on the menu to copy the email address to the clipboard. You can paste the email address later when creating a new contact or sending a new email message.



The browser also recognizes some phone numbers and addresses that allow you to call the phone number or locate the address in Google Maps™. Recognized phone numbers and addresses are highlighted in green when navigated to.

Link	What to do
Location address	Tap the address to open Google Maps and locate the address.
Phone number	Tap to open the Phone screen to call the phone number.

Tip: Zoom in on the Web page when links are too small for tapping directly on the screen.

Downloading Applications From the Web

Before you can download applications from the Web, you must first enable downloading from the device settings.

1. Press  >  and tap **Settings > Applications**.
2. Select the **Unknown sources** check box.
3. When the Attention dialog box opens, tap **OK**.

Note: All downloaded applications are saved to the microSD card. Before you download an application from the Web, make sure that you have installed a microSD card on your device. For information on how to install a microSD card, “Inserting the microSD Card” on page 73.

WARNING: Applications downloaded from the Web can be from unknown sources. To protect your device and personal data, download applications only from trusted sources such as Android Market. Refer to “Downloading Applications and Games From Android Market” for details.

To view your downloads:

- ▶ On the browser screen, press  and tap **More > Downloads**.

Copying Text, Looking Up Information, and Sharing

You can select text on a Web page and then:

- Copy it.
- Look it up on Wikipedia or Google Dictionary.
- Get a translation of the text from Google Translate.
- Share the text in a new email, text, or multimedia message or in your status update on a social network.

Selecting Text

1. Press and hold on a word.

Tip: To select text in a link, press and hold the link, and then tap **Text selection**.

2. Drag the start and end markers to highlight the surrounding text you want to select. You can drag to increase or decrease the text selection area.

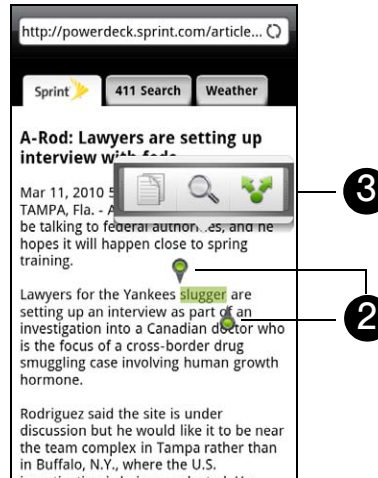

3. Tap an icon to copy, search or translate, or share the selected text.





When you select a larger block of text, the appearance of the markers changes. You can drag these markers up or down to select multiple paragraphs of text.



Copying and Pasting Text

1. After you have selected the text you want to copy, tap . The selected text is then copied to the clipboard.
2. In a text box (for example while composing a message), press and hold at the point where you want to paste the text.
3. Tap **Paste**.

Searching or Translating Text

1. After you have selected the text you want to search or translate, tap .
2. Tap one of the following tabs:
 - **Wikipedia**  Look for related information about the selected text in Wikipedia.
 - **Google Translate**  Translate the selected text to another language.
 - **Google Dictionary**  Look up the selected text in the dictionary.

Pasting Text in a New Message or Social Network Status Update

1. After you have selected the text you want to share, tap .
2. Select an option to paste the selected text in a new email, text or multimedia message or in your status update on a social network such as Twitter.



Managing Bookmarks and Previously Visited Web Pages

You can store as many bookmarks as you want on your device. You can also access a convenient History list of the sites you have visited, or quickly view the pages that you access most often.



To bookmark a website:

1. While viewing a Web page, press , and then tap **Add bookmark**. The New bookmark screen opens.
2. Edit the bookmark **Name** if needed, and then tap **Done**.



To open a bookmark:

1. On the browser screen, press  and tap **Bookmarks**.
2. Select the bookmark you want to open by sliding your finger up or down.
3. On the **Bookmarks** tab , navigate to the bookmark you want to open, and then tap it.

To edit a bookmark:

1. On the browser screen, press  and tap **Bookmarks**.
2. On the **Bookmarks** tab , press  and tap **Edit**.
3. Tap the bookmark you want to edit.
4. Enter your changes and tap **Done**.



To viewing a previously visited page:

1. On the browser screen, press  and tap **Bookmarks**.
2. On the **History** tab , navigate to the page you want to view and then tap the page.

To clear the list of previously visited pages:

1. On the browser screen, press  and tap **Bookmarks**.
2. On the **History** tab , press , and then tap **Clear history**.

To view a page that you often visit:

1. On the browser screen, press  and tap **Bookmarks**.
2. On the **Most Visited** tab , navigate to the page you want to view, and then tap the page.

To clear the list of most visited pages:

1. On the browser screen, press  and tap **Bookmarks**.
2. On the **Most Visited** tab , press , and then tap **Clear all**.

To change the view of bookmarks or most visited pages:

On the browser screen, press  and tap **Bookmarks**.

On the **Bookmarks** tab  or the **Most visited** tab , press , and then tap **Thumbnails**, **List**, or **Grid** to change the view. For example, if you are in Thumbnails view and you want to view bookmarks in a grid, press  and tap **List**, and then press  and tap **Grid**.



Accessing Email Messages

You can send and receive email messages from your favorite POP3/IMAP email account, or from the Exchange ActiveSync account that you use at work right from your device. **Mail** and **Gmail** allows you to stay connected 24 hours a day anywhere on the Nationwide Sprint Network.

Email

The Mail application lets you send and receive email from your webmail or other accounts, using POP3 or IMAP. It also lets you access your Exchange ActiveSync email and other features on your device.

Adding a POP3/IMAP Email Account



1. Press  and tap  > **Mail**.
2. Do one of the following:
 - If this is your first time to add an email account in Mail, tap **Other (POP3/IMAP)** on the Choose a mail provider screen.
 - If you have already added an email account in Mail, tap  on the upper-left corner, and then tap **New Account**. If the Choose a mail provider screen is displayed, tap **Other (POP3/IMAP)**.
3. Enter the **Email address** and **Password** for the email account and then tap **Next**.

Important: If the account type you want to set up is not in the device database, you will be asked to enter more details. It is recommended that you get all pertinent information for the email account such as incoming and outgoing server settings before you proceed.

4. Enter the **Account name** and **Your name** and tap **Finish setup**.

Adding an Exchange ActiveSync Account

If you synchronize your device with your work Exchange ActiveSync account, you can read, manage, and send email in the same easy way as with a POP3/IMAP account. However, you can also access some powerful Exchange features. You can only add one Microsoft Exchange ActiveSync account on your device.

1. Press  and tap  > **Mail**.
2. On the Choose a mail provider screen, tap **Microsoft Exchange ActiveSync**.
3. Enter the Exchange ActiveSync account details and then tap **Next**.

Note: Your corporate Exchange Server must support auto-detect for the device to automatically set up the Exchange ActiveSync account. If your corporate Exchange Server does not support auto-detect, you will need to enter your Exchange Server settings after you tap Next. Ask your Exchange Server administrator for details.

4. Select the type of information you want to synchronize and tap **Finish setup**.

Creating Another Email Account

- If you are in the Inbox of an email account, press  and then tap **More > New account**.

Composing and Sending Email

1. Press  and tap  > **Mail**.
2. On the email account Inbox, press  and tap **Compose**.

Tip: Tap  on the upper-left corner to switch to a different email account.



3. Fill in one or more recipients. You can:
 - Enter email addresses directly in the **To** field. If you're sending the email to several recipients, separate the email addresses with a comma. As you enter email addresses, any matching addresses from your contacts list are displayed. Tap a match to enter the address directly.
 - Tap the  icon, and then select the email addresses of the contacts to whom you want to send the email. You can also select contact groups as recipients, or add contacts from the company directory if you have set up an Exchange ActiveSync account on your device. When you have selected all the message recipients, tap **Done**.

Tip: If you want to send a carbon copy (Cc) or a blind carbon copy (Bcc) of the email to other recipients, press  and tap **Show Cc/Bcc**.

4. Enter the subject, and then compose your message.
5. To add an attachment, press , tap **Add attachment**, and choose from the following options:
 - **Picture** Select **Camera** to take a photo and attach it, or **Gallery** to attach a photo from your storage card.
 - **Video** Select **Camcorder** to capture a video and attach it, or **Videos** to attach a video from your storage card.
 - **Audio** Select **Voice Recorder** to make a voice recording and attach it, or **Music & sounds** to attach a music file or voice recording from your storage card.
 - **Location** You can attach location information. Send your current location (requires GPS to be turned on), a location stored in Footprints, or a location you pick on a map. For more information about GPS, maps, and Footprints, see "GPS Services" on page 155.
 - **Document** Attach a PDF file or an Office document such as a text file or a spreadsheet.
6. Tap **Send** to send the message immediately, or tap **Save as draft** if you want to send it later.

Note: To open a draft email, in the email account Inbox, press , and then tap **Folders > Drafts**.

Viewing and Replying to Email

1. Press  and tap  > **Mail**.
2. On the email account Inbox, tap the message you want to view.

Tip: Tap  on the upper-left corner to switch to a different email account.

3. Tap **Reply** or **Reply all** to reply to the message.

Managing Your Email Inbox

To view your email inbox:

1. Press  and tap  > **Mail**.
2. Tap a tab at the bottom of the screen to filter the inbox.

Tap to view a different email account or add a new email account.

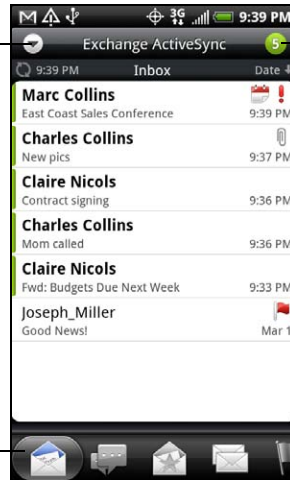

Number of unread email messages.

Marked (Exchange ActiveSync only)

Filter tabs.
See "Inbox filter tabs" for details.

Inbox filter tabs:



1. **Received:** Displays email messages as individual items.
2. **Conversations:** Displays messages as conversations, grouped according to the subject line. Tap a subject in the list to show the email conversation.
3. **VIP group:** Displays messages from contacts in your VIP group. To add contacts to the VIP group from this tab, tap **Add contact to group**, select the contacts you want to add, and then tap **Save**. For more information on contact groups, see "Working with Groups" on page 48.
4. **Unread:** Displays unread messages.
5. **Marked:** (Exchange ActiveSync only) Displays all flagged messages.
6. **Meeting invitations:** (Exchange ActiveSync only) Displays meeting invitations which you have not yet accepted or declined.
7. **Attachments:** Displays all messages that have attachments.

To refresh an email account:

Whatever your automatic synchronization settings are, you can also synchronize your sent and received emails manually at any time.

- ▶ While in the account you want to synchronize, press  and tap **Refresh**.

To sort email messages:

1. On the email account Inbox, press  and tap **Sort**.
2. Select from the options to sort email messages by date received, priority, subject, sender, or size.

To delete an email message:

1. On the email account Inbox, press and hold the message you want to delete.
2. On the options menu, tap **Delete**.

To delete multiple email messages:

1. On the email account Inbox, press  and tap **Delete**.
2. Select the messages you want to delete, and then tap **Delete**.



Using Exchange ActiveSync Email Features

To synchronize Exchange ActiveSync email:



You can set Exchange ActiveSync to automatically check for new Exchange ActiveSync emails. For more information, see “Synchronizing Exchange ActiveSync” on page 35.

To flag email messages:

For an Exchange ActiveSync account, you can flag email messages to help you keep track of them.



1. Press  and tap  > **Mail**.
2. On the email account Inbox, tap the message you want to view.

Tip: Tap  on the upper-left corner to switch to a different email account.



3. Tap the white flag () on the upper-right corner of the screen to mark the message. The flag turns red () when you mark the message.

To set out of the office status:

You can set your Out of Office status and auto-reply message right from your device.

1. Press  and tap  > **Mail**.
2. Switch to the Exchange ActiveSync account.
3. Press  and then tap **More > Out of the office**.
4. Tap the field below **I am currently**, and then select **Out of the office**.
5. Set the dates and times for the period when you will be out of the office.
6. Enter the auto-reply message.
7. Tap **Save**.

To send a meeting request:





1. Press  and tap  > **Mail**.
2. Switch to the Exchange ActiveSync account.
3. Press  and then tap **More > New meeting invitation**.
4. Enter the meeting details, and then tap **Send**.

To set the priority for an email message:



You can set the priority for an email message you send with your Exchange ActiveSync account.

1. While composing the message, press .
2. Tap **Set priority**.
3. Select the priority for the message.
If you selected **High** or **Low** priority, the priority appears below the subject line of the message.

Editing Email Account Settings

1. Press  and tap  > **Mail**.
2. Switch to the email account you want to edit.
3. Press  and tap **More > Settings**, and choose from these options:
 - **Account settings:** Change the email account settings such as the name, email address, password, and description.
 - **General settings:** Set the font size when reading email messages, enable, disable or set the signature, set the account as the default email account, and set where to save email attachments.
 - **Send & Receive:** Set the maximum email file size limit for incoming messages and the frequency with which to check for new messages and how many to check for. You can also choose to have your sent email messages BCC'd to yourself.
 - **Notification settings:** Set email notification settings.
 - **Delete account:** Tap to delete the email account.
4. Press  to save your changes.

Deleting an Email Account

1. Press  and tap  > **Mail**.
2. Switch to the email account you want to delete.
3. Press  and tap **More > Settings > Delete account**.

Adding the Mail Widget

Add the Mail widget to let you view your POP3/IMAP or Exchange ActiveSync emails on the Home screen. To learn how to add widgets, see “Customizing the Home Screen” on page 23.

Gmail

Gmail is Google’s Web-based email service. Gmail is configured if you chose to set up a Google account when you first set up your device. Depending on your synchronization settings, your device’s Gmail is automatically synchronized with your Gmail account on the Web. For more information, see “Synchronizing Google Apps” on page 34.

To open Gmail:

- Press  and tap  > **Gmail**.

The Inbox conversations list is your default Gmail view. All your received emails are delivered to your Inbox.

Gmail groups each message you send with all the responses you receive. This conversation list continues to grow as new replies arrive, so you can always see your messages in context. A new message or a change to the subject of a current message will begin a new conversation.

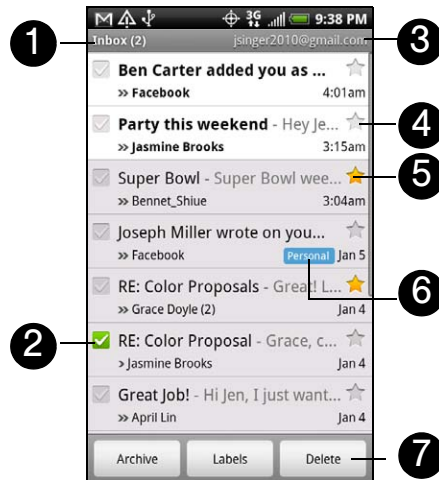

1. Displays the folder name (or Label) and number of unread email messages.
2. Checked email. Select one or more emails to apply an action. Batch operations need to be selected. (See “Changing Gmail Settings” for details.)
3. The Google Account you are currently viewing. To view another account, see the next section.
4. Unread messages are displayed in bold.
5. Starred email. Tap to add or remove the star.
6. Message label.
7. Displays actions available for checked email. This will not show if there is no email selected in the inbox.

To switch to another Google Account:

If you have set up more than one Google Account on your device, you can switch between accounts in Gmail.

1. Press and tap > **Gmail**.
2. Press and then tap **Accounts**.
3. Tap the account to switch to.

To refresh Gmail:

- ▶ While viewing the Gmail Inbox, press and tap **Refresh** to send or receive new email messages and to synchronize your email with your Gmail account on the Web.

Creating and Sending Email

To create and send an email message:

1. In the Gmail Inbox, press and tap **Compose**.
2. Enter the message recipient’s email address in the **To** field. If you are sending the email to several recipients, separate the email addresses with a comma. You can add as many message recipients as you want. As you enter email addresses, any matching addresses from your contacts list are displayed. Tap a match to enter that address directly.

Note: If you want to send a carbon copy (Cc) or a blind carbon copy (Bcc) of the email to other recipients, press and tap **Add Cc/Bcc**.

3. Enter the email subject and compose your message.

Tip: If you want to add a photo attachment, press  and tap **Attach**. Locate the photo you want to attach, and then tap it.

4. After composing your email, tap **Send**.

Note: While composing the email, tap **Save as draft** or press the  button to save email as a draft. To view your draft email messages, in the Inbox, press  and tap **View labels > Drafts**.

To add a signature to an email message:

1. In the Inbox, press  and tap **Settings > Signature**.
2. Enter your signature in the text box and tap **OK**.

Tip: You can create a signature consisting of multiple lines of text. At the end of each line of text, tap  on the onscreen keyboard to create another line.

To view your sent messages:

- ▶ In the Inbox, press  and tap **View labels > Sent**.

Receiving and Reading Email

Depending on your notification settings, the device plays a ring tone, vibrates, or displays the email message briefly in the status bar when you receive a new email. A new email message () icon also appears on the notifications area of the status bar to notify you of a new email message.

Note: For more information on email notification settings, refer to the “Changing Gmail Settings” for details.

To refresh your inbox manually, press  and then tap **Refresh**.

Gmail groups each message you send with all the responses you receive. This conversation list continues to grow as new replies arrive, so you can always see your messages in context. Conversations are also referred to as message threads. A new message or a change to the subject of a current message will begin a new thread.

To view email:

1. Do one of the following:
 - Press , press and hold the status bar, and slide down your finger on the screen to open the Notifications panel. Tap the new email message to view it.
 - While in the Inbox, tap the unread email or the conversation with the unread email message to view it.
2. To scroll through the messages in the conversation, slide your finger up/down on the screen.

Online status.
Appears when the contact is a Google Talk friend and you are signed in to Google Talk.

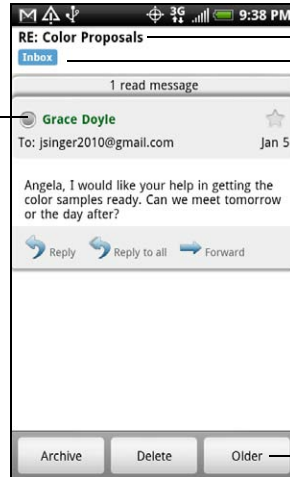

Message subject

Message label

Email message or conversation options

3. To manage the email message or conversation, do any of the following:

- Tap **Archive** to remove the conversation from your Inbox while still keeping it stored in your Google Account.

Note: To display your archived messages, in the Inbox, press  and then tap **View labels > All Mail**.

- Tap **Delete** to delete the conversation from your Google Account. If you delete the conversation accidentally, you can tap **Undo** in the yellow bar at the top of the screen to undelete it.
- Tap **Older** to see the previous conversation in your Inbox.

Press  to see more options.

Replying to or Forwarding Email

1. In the message thread, scroll down to the end of the conversation.
2. Tap **Reply**, **Reply to all**, or **Forward**.
3. If you selected **Reply** or **Reply all**, enter your reply message.
– or –
If you selected **Forward**, specify the message recipients and enter your message.
4. Scroll down to the end of the message and tap **Send**.

Muting a Conversation

If you're part of a long message conversation that isn't relevant, you can 'mute' the conversation to keep all future additions out of your Inbox.

While viewing the message thread, press  and tap **More > Mute**.

Reporting a Conversation as Spam



The Gmail webmail service works hard to prevent spam (unwanted and unsolicited "junk" mail) from reaching your Inbox. But when spam makes it through, you can help improve the service by reporting the conversation as spam.

While viewing the message thread, press , and then tap **More > Report spam**.

Managing Conversations and Email

To search for messages:

You can search for messages that contain one or more words in their contents or in their addresses, subjects, labels, and so on. When you search for messages, all of the messages in your Gmail account on the Web are included (except those labeled **Trash** or **Spam**), not just those that you've synchronized onto your device.

1. In the Inbox, press  and tap **Search**.
2. Enter the word or words to search for.
3. Tap , or tap the Enter key on the onscreen keyboard.

A conversation list opens, displaying all of the conversations with messages that contain the words you searched for. The words you searched for are displayed in the title bar. You work with the conversations in this list just as you would with the conversations in your Inbox or any other conversation list.

To star a message:

You can star an important message so that you can easily find it again. Conversations with starred messages are displayed with a star in your Inbox and other conversation lists. To view just conversations with starred messages, see “To view conversations by label” later.

Do one of the following:

- While reading a message, touch the star in its header.
- When viewing a conversation, touch its star to start the newest message in the conversation.

To unstar a message, touch its star again. You can also touch a star in a conversation list to unstar all messages in the conversation.

To label a conversation:

You can organize conversations by labeling them. Gmail has several preset labels you can use, and you can also add your own labels, using Gmail on the Web.

1. While viewing the messages in a conversation, press  and then touch **Change labels**.
2. Select the labels that you want to assign to the conversation, and then tap **OK**.



To view conversations by label:

You can view a list of the conversations that have the same label.

1. When viewing your Inbox or another conversation list, press , and then touch **View labels**.
2. Touch a label to view a list of conversations with that label.

The conversation list resembles your Inbox, but the label replaces “Inbox” in the title bar. You work with labeled conversations lists in the same way as with your Inbox.

To change Gmail synchronization settings:



1. Press  and tap  > **Gmail**.
2. Press , and then tap **Settings > Labels**.
3. To set the number of days to synchronize, tap **Number of days to sync**.
4. To set synchronization for a particular label, tap the label. You can select to synchronize the default number of days, or you can sync all or none of the label's messages.

To work with conversations in batches:

You can archive, label, delete, or perform other actions on a batch of conversations at once, in your Inbox or in another labeled list of conversations.

1. In the Inbox or other conversation list, select the check boxes for the conversations you want to work with as a batch. When you select a check box, the **Archive**, **Labels**, and **Delete** buttons are displayed at the bottom of the screen.
2. Tap the **Archive**, **Labels**, or **Delete** button to perform one of those actions on the batch of conversations, or press  for more options.



Changing Gmail Settings

1. Press  and tap  > **Gmail**.
2. In the Inbox, press  and then tap **Settings**.
3. Set the following options:
 - **Signature**: Tap to enter a signature that is appended at the end of your email messages.
 - **Confirm delete**: Select the check box to show a confirmation box when you delete a conversation.
 - **Batch operations**: Select the check box to show the batch operations feature. The batch operations feature lets you archive, delete, or apply a label to multiple email messages at once.
 - **Clear search history**: Remove the searches you have performed.
 - **Labels**: Tap to select which Gmail labels to synchronize.
 - **Email notifications**: Select the check box to show a notification icon on the status bar when you receive a new email message.
 - **Select ringtone**: Tap if you want your device to ring when a new email message arrives. On the **Ringtone** menu, select a ring tone specific to new email messages. The ring tone plays briefly when selected. If you don't want a ring tone to play when you receive a new email message, tap **Silent**. Then tap **OK** to confirm your ring tone selection.
 - **Vibrate**: Select if you want your device to vibrate when you receive a new email message.

Google Talk

Google Talk is Google's instant messaging program. It lets you communicate with other people that also use Google Talk. If you signed in to your Google Account when you first set up the device, you are already signed in to Google Talk.

To open Google Talk:

1. Press  and tap  > **Talk** > **Next** > **Sign in**.
2. Enter your Google Account username and password, and then tap **Sign in**.

When you are signed in to Google Talk, your online status in Google Talk will also appear in other Google Apps such as Gmail and Google Maps.

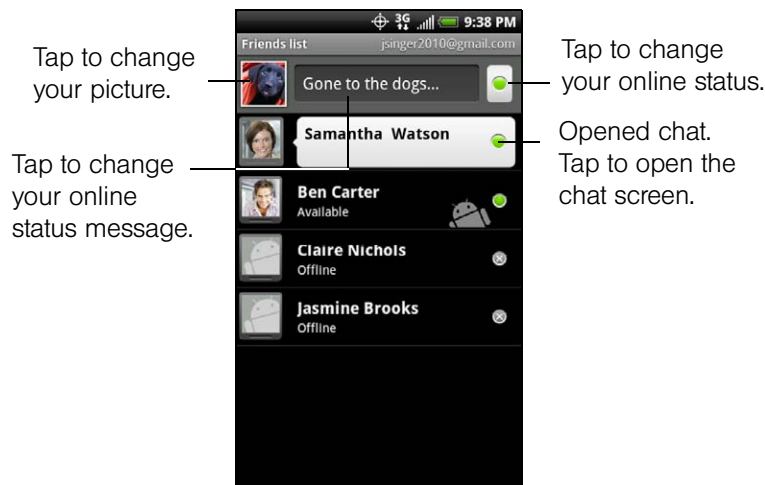

Chatting with Friends

To start a chat:

1. Tap a friend in the Friends list.
2. Chat with your friend by entering text using the onscreen keyboard.

Tip: To insert a smiley, press  and tap **More > Insert smiley**. Tap a smiley to insert it into your message.

3. After entering your message, tap **Send**.

To switch between active chats:

You can switch between chats if you have more than one chat going.

1. While on a chat screen, press  and tap **Switch chats**.

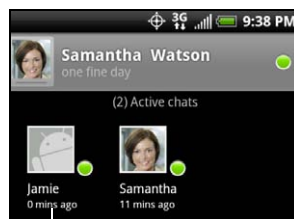

Tap to switch chat with this friend.

2. In the list of all active chats, tap the friend you want to chat with.

To invite a friend to join a group chat:

While on a chat screen, press , and then tap **Add to chat**.



Tap the friend you want to invite. The friend you invited and the current participants receive an invitation to a group chat. Each one who accepts the invitation joins the group chat.

To close a chat:

- ▶ In your Friends list, press and hold a friend with an active chat and tap **End chat** on the menu.
 - or –
 - While on a chat screen, press  and tap **End chat**.

Changing Your Online Status and Picture

To change your online status and message:

1. Tap the online status icon () beside your name, and then select the status you want on the menu. In addition to the standard status settings, you can also select a message that you've entered previously. Or tap **Clear custom messages** to erase them and start over. Your status and any message appear in your contact's Friends lists and in other locations where your status or status message are displayed.
2. Tap the text box on the left of your online status icon and then enter your status message using the onscreen keyboard.
3. Tap .

To change your picture:

1. In your Friends list, tap the picture to the left of your status message.
2. In the Select an album screen, tap the album where the picture you want to use is located.
3. Tap the picture you want to use.
4. Drag the green box to select the portion of the picture to crop, and then tap **Save**.

Managing Your Friends List

Friends in your friends list is sorted by their online status — active chats, online, busy, and offline. Within the status groupings, friends are listed alphabetically.

By default, only the friends that you frequently communicate with — the most popular — are in the Friends list. If you want to display all your friends, press  and tap **All friends**.

Tip: To switch back to displaying only your most popular friends, press  and tap **Most popular**.

To add a new friend:

You can invite anyone with a Google Account to become your friend in Google Talk, so you can chat with each other and view each others' online status.

1. In the Friends list, press  and tap **Add friend**.
2. Enter the Google Talk instant messaging ID or Google email address of the friend you want to add.

Note: When you add a friend with an instant messaging ID and that friend has been saved in your contacts list, matching contacts will display on the screen as you enter information. You can tap the contact or continue entering the IM information.

3. Tap **Send invitation**.

To view pending invitations:

- ▶ In the Friends list, press  and tap **Invites**.

All the friends to whom you've extended invitations to become friends on Google Talk appear in the list until they accept or cancel your invitation.

To accept an invitation to become a friend:

When a contact invites you to become a friend in Google Talk, you receive a notification in the status bar and the invitation appears in your Friends list.

1. In the Friends list, tap **Chat invitation**.
2. Do one of the following:
 - Tap **Accept** in the menu that opens to accept the invitation.
 - Tap **Cancel** if you don't want to chat with and share your Google Talk status with the sender.
 - Tap **Block** if you want to block the sender from chatting with you on Google Talk.

To view all friends or only those most popular with you:

By default, only the friends that you frequently chat with – the most popular – are shown in the Friends list. But you can view all friends instead.

1. In the Friends list, press  and tap **All friends**.
2. To switch back to just the friends with whom you chat most frequently, tap **Most popular** in the menu.

To make a friend popular:

1. In the Friends list, press and hold a friend's name.

Note: If you cannot see the friend, press , and then tap **All friends**.

2. In the options menu, tap **Always show friend**.

To block a friend:

You can block a friend from sending you messages. When blocked, your friend is also removed from your Friends list.

1. In the Friends list, locate the friend you want to block.

Note: If you cannot see the friend, Press , and tap **All friends**.



2. Press and hold the friend's name, and tap **Block friend**. Your friend is removed from your friends list and is added to the blocked friends list.

Note: To unblock a friend, in the Friends list, press , and tap **Blocked**. In the Blocked friends list, tap the name of the friend you want to unblock, and tap **OK** when prompted.

Changing Google Talk Settings

To show the mobile indicator:

You can check the type of device your friend is using to chat in Google Talk. In the friends list, check the image that appears to the right of your friend's name. When you do not see an image, it indicates that your friend signed in last from a computer.



1. In the Friends list, press  and tap **More > Settings**.
2. Select the **Mobile indicator** option and press . The mobile indicator icon will appear along with your name in other people's Friends list and will let your friends know what type of mobile device you are using.



Indicates that the friend is using an Android device.



To set notifications for new instant messages:

You can set the device to play a sound, vibrate, or display a notification icon in the status bar each time you receive a new instant message.

1. In the Friends list, press  and tap **More > Settings**.
2. Do one of the following:
 - Select the **IM notifications** check box to receive a notification () in the status bar when a new instant message arrives.
 - Tap **Select ringtone** to select the ring tone to use when a new instant message arrives. The ring tone briefly plays when selected. If you don't want a ring tone to play when you receive a new instant message, select **Silent**.
 - Select the **Vibrate** check box to vibrate your device when you receive a new instant message.

To sign in automatically:

You can sign in to your Google Talk account automatically every time you turn on your device.



1. In the Friends list, press  and tap **More > Settings**.
2. Select the **Automatically sign in** check box.
3. Press  to save your setting.

Downloading Applications and Games From Android Market

Android Market™ is the place to go to find new apps for your device. Choose from a wide variety of free and paid apps ranging from productivity apps, entertainment, to games. When you find an app you want, you can easily download and install it on your device with just a few taps of your finger.

To access Android Market, you must first connect to the Internet using your device's Wi-Fi, Sprint 4G, or data connection and sign in to your Google Account.

Opening Android Market

1. Press  and tap  > **Market**.
2. When you open Android Market for the first time, the Terms of Service window will appear. Tap **Accept** to continue.

Tap to display the available apps or games on Android Market, or display the apps that you have already downloaded and installed from Android Market.

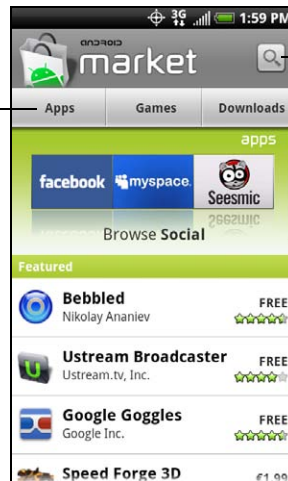





Tap to search Android Market for apps to install on your device.

Featured apps list. Tap an app to read a description about the app and user reviews.

Finding and Installing an Application

When you install apps from Android Market and use them on your device, they may require access to your personal information (such as your location, contact data, and more) or access to certain functions or settings of your device. Download and install only apps that you trust.



1. Press  and tap  > **Market**.
2. To find an app in Android Market, you can:
 - Browse through featured apps. Scroll through the list of featured apps when you open Android Market.
 - Browse apps by categories. First, tap **Apps** or **Games**, and then tap a category. Under a category, you can filter the apps by **Top paid**, **Top free** or **Just in**.
 - Search for an app. Tap  on the Android Market home screen, enter the name or type of app you're looking for, and then tap  to the right of the search box.
3. Tap an app to read a description about the app and user reviews.
4. Tap **Install** (for free applications) or **Buy** (for paid applications).

Note: You need a Google Checkout account to purchase items on Android Market. See "Creating a Google Checkout Account" to set up a Google Checkout account if you do not have one.

5. The subsequent screen notifies you whether the app will require access to your personal information or access to certain functions or settings of your device. If you agree to the conditions, tap **OK** to begin downloading and installing the app.

If you selected a paid application, after tapping **OK**, you're redirected to the Google Checkout screen to pay for the application before it's downloaded to your device.

WARNING: **Read it carefully!** Be especially cautious with applications that have access to many functions or a significant amount of your data. Once you tap **OK** on this screen, you are responsible for the results of using this item on your device

After installing an app, tap  on the upper-left corner of the screen to return to Android Market home. You can also press , and then tap **Home**.

Creating a Google Checkout Account

You must have a Google Checkout account associated with your Google Account to purchase items from Android Market.

Do one of the following:

- ▶ On your computer, go to <http://checkout.google.com> to create a Google Checkout account.

– or –



The first time you use your device to buy an item from Android Market, you're prompted to enter your billing information to set up a Google Checkout account.

WARNING: When you've used Google Checkout once to purchase an application from Android Market, the device remembers your password, so you don't need to enter it the next time. For this reason, you should secure your device to prevent others from using it without your permission. For more information, see "Security Settings" on page 33.







Requesting a Refund for an Application

If you are not satisfied with an application, you can ask for a refund within 24 hours of the purchase. Your credit card is not charged and the application is uninstalled from your device.

If you change your mind, you can install the application again, but you can't request a refund a second time.



1. Press  and tap  > **Market** > **Downloads**.
2. Tap the application to uninstall for a refund. The details screen for the application opens.
3. Tap **Uninstall & refund**. Your application is uninstalled and the charge is cancelled.
4. Choose the reason for removing the application, and then tap **OK**.

Opening an Installed Application

- ▶ On the status bar, check if you see the  icon. If you see the  icon, open the Notifications panel, and then tap the app to open it.
– or –
- ▶ Press  and tap  > **Market** > **Downloads**. On the Download screen, tap the app to open it.
– or –
- ▶ Press , and then tap . On the All apps screen, locate the app, and then tap it.

Uninstalling an Application

You can uninstall any application that you have downloaded and installed from Android Market.

1. Press  and tap  > **Market** > **Downloads**.
2. On the Downloads screen, tap the application you want to uninstall, and then tap **Uninstall**.
3. When prompted, tap **OK** to remove the application on your device.
4. Choose the reason for removing the application, and then tap **OK**.

Getting Help



If you ever need help or have questions about Android Market, press , and then tap **Help**. The Web browser will take you to the Android Market Help Web page.

Peep

Peep™ is a Twitter client that lets you enjoy “tweeting” on your device. Send out tweets, read and receive tweets from people, search for new Twitter users to follow, all from your device.

Note: You need to be signed in to your Twitter account to use Peep.

Opening Peep

- Press , tap , and then tap **Peep**. (You may need to scroll down the screen to see the icon.) Peep opens in the **All tweets** tab. Slide your finger on the bottom row to go to the tab you want.

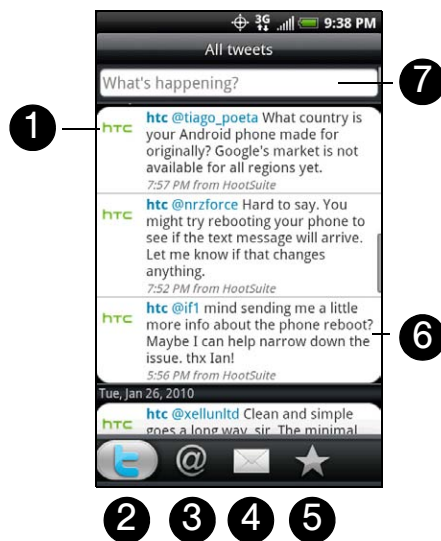

1. Tap to view the Twitter user's profile. This also shows you all tweets from this Twitter user.
2. Shows all the tweets from people you follow and tweets that you have sent out.
3. Shows all tweets that mentions your username using the “@[your username]” convention.
4. Shows all private/direct messages that you have received or sent out.
5. Shows tweets that were marked as favorites.
6. Press and hold an item to open the options menu to let you reply, send a direct message, Retweet (share), add to your favorites, or view your profile.
7. Tap to enter a tweet to send out.

Sending a Tweet

1. On the **All tweets** tab, tap the “What’s happening?” text box.
2. Enter your tweet and then tap **Update**.



1. Tap to post a picture from Gallery or camera to your default photo hosting site and add the link to the picture into the tweet.
2. Enter your tweet here.
3. Tap to insert your location into the tweet. You can choose to add map link, insert your location name, or insert your position coordinates.

Note: On the Peep screen, press  and tap **More > Settings > Services** to check or change your photo hosting site, location options, and URL shortening host.



Sending a Direct Message

- ▶ On the Peep screen, press  and tap **New message**.
– or –

On the **All tweets** or **Direct message** tab, press and hold the person you want to send the direct message to, and tap **Send direct message** on the options menu.

To view your direct messages, go to the **Direct Message** tab.

Searching for Twitter Users to Follow

1. While on the Peep screen, press .
2. Tap the text box with the words “Search Twitter” and then enter search criteria. Press  again or tap  on the screen.
3. On the Search result screen, scroll through the list to look for the twitter user you want to follow, and then tap it.

Tip: The search results will also list down tweets that contain the search word.

4. Press , and then tap **Follow**.

To stop following a Twitter user:



1. On the **All Tweets** tab, tap the name of the Twitter user you want to stop following.
2. Press , and then tap **Unfollow**.

Setting Peep Options

- ▶ On the **All tweets** tab, press , and then tap **More > Settings**. You can set these options:
 - **Account settings:** Sign out of your Twitter account.
 - **General settings:** Choose whether to show the screen name or the real name of the people you follow.
 - **Send & receive:** Set the frequency to check for new tweets and set the number of tweets to download.
 - **Services:** Set your photo hosting site, photo quality, location options, and URL shortening host.
 - **Notification settings:** Select when to be notified and how you want to be notified.

Adding the Twitter Widget

Add the Twitter widget to let you send and follow your tweets right on the Home screen.

1. Press  and tap .
2. In the **Add to Home** options menu, tap **Widget > Twitter**.
3. Choose the widget style, and then tap **Select**.
4. Drag the widget to a blank space on the Home screen, and then release.

Stocks

Stocks allows you to add, view, and analyze stocks and stock market movements using updated financial information.



Opening Stocks

- ▶ Press  and tap  > **Stocks**. (You may need to scroll down the screen to see the icon.)





1. List of your stock quotes and stock market indices. Tap an item to view its intraday chart and other details.
2. Tap to update the stock information.
3. Tap to add a stock quote or stock market index.
4. Shows the time the information was last updated.

Adding a Stock Quote or Stock Market Index

1. On the Stocks screen, tap .
2. Enter the stock quote or stock market index on the text box and tap .
3. On the results list, tap the stock quote or stock market index you want to add.

Changing the List Order

1. On the stocks screen, press  and tap **Rearrange**.
2. Press and hold  at the end of the item you want to move. When the row is highlighted in green, drag it to its new position, and then release.
3. Tap **Done**.

Deleting an Item

1. On the Stocks screen, press  and tap **Delete**.
2. Select the items you want to delete and tap **Delete**.

Setting Stock Information Update Frequency

1. On the Stocks screen, press  and tap **Settings**.
2. Select the **Auto-sync data** check box.



Note: Downloading stock information automatically may incur additional data connection fees.

3. Tap **Set download frequency**, and then select frequency to check for updates.

Manually Updating Stock Information



- On the Stocks screen, press  and tap **Update**.

Adding the Stocks Widget

1. Press  and tap .
2. In the **Add to Home** options menu, tap **Widget > Stocks**.
3. Choose the widget style, and then tap **Select**.
4. Drag the widget to a blank space on the Home screen, and then release.



Weather

Weather lets you view the current weather as well as weather information for the next four days of the week. Weather can display weather information for your city or weather for up to ten cities. If you consented to turn location service on, you'll see the weather of your current location right on the HTC Clock widget of your Home screen.

Note: Turn location services on your device so that you'll be able to check your current location's weather on the HTC Clock widget, Weather application, and the Weather widget. Press  > , tap **Settings > Location**, and then select the **Use wireless networks** check box.

You can also use the Weather application to check the current weather and weather forecasts for the next four days of the week. In addition to your current location's weather, this application also displays the weather forecasts of other cities around the globe.

Opening Weather

► Press  and tap  > **Weather**. (You may need to scroll down the screen to see the icon.)



To view the weather in other cities, swipe your finger upward or downward on the screen.



Adding a City

1. On the Weather screen, tap .
2. Enter the location you want to add on the text field. As you enter text, the list is filtered to show the possible locations based on the letters you entered.
3. Tap the city to select it.

Changing the Order of Cities

1. On the Weather screen, press  and tap **Rearrange**.
2. Press and hold  at the end of the item you want to move. When the row is highlighted in green, drag it to its new position, and then release.
3. Tap **Done**.

Deleting a City

1. On the Weather screen, press  and tap **Delete**.
2. Select the cities you want to delete and tap **Delete**.

Changing Weather Options

1. On the Weather screen, press  and tap **Settings**.
2. Select the options you want:
 - Select the **Update automatically** check box to automatically download weather updates after a period of time.
 - To set an auto update schedule, tap **Update schedule** and choose a schedule.
 - Tap **Temperature scale** to choose whether to display weather in **Celsius** or **Fahrenheit**.

About the Weather Widget

Use the Weather widget to instantly check weather forecasts of your current location and other cities without having to open the Weather application.

The Weather widget comes in different looks and styles. You can add this widget to the Home screen, if it's not yet added. To find out how you can add a widget, see "Customizing the Home Screen" on page 23.

News Feeds

Use News to subscribe to news feeds to keep up with the latest buzz on the Internet. News monitors RSS feeds from your favorite news sites, blogs and more, and downloads the most current updates.

The News Screen

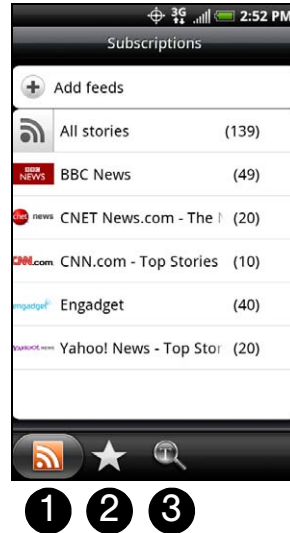

1. **Subscriptions tab:** Displays the channels that you are subscribed to. Tap a channel to show the stories for that particular channel.
2. **Starred tab:** Displays channels and the number of stories (enclosed in parenthesis) that have been starred. Tap a channel to show the starred stories for that channel, then tap a story to read it.
3. **Keywords tab:** Displays the keywords that you have created and the number of stories (enclosed in parenthesis) that match them. Tap a keyword to display the stories that contain the particular keyword.

Subscribing to a News Channel From a List

1. Press and then tap > **News**.
2. On the Subscriptions tab, tap **Add feeds**.
3. Tap one of the categories on the screen to open the available channels.
 - Tap **Search more** to search the Web for other channels.
 - Tap **Add Google news feed** to subscribe to a channel from Google News.
4. Select the channels you want to subscribe to.
5. Repeat steps 3 to 4 to subscribe to more channels.
6. Tap **Done**.

Subscribing to a News Channel by Entering a URL

1. Press and then tap > **News**.
2. On the Subscriptions tab, tap **Add feeds** > **Add from URL**.
3. Enter the complete URL for the RSS feed, and then tap **Done**.



Setting Update Frequency for Stories

Set News to automatically check for updates for the channels that you are subscribed to.

1. Press  and then tap  > **News**.
2. While on the Subscriptions tab, press , and then tap **Settings** > **Check frequency**.
3. Tap the frequency you want.





Tip: To manually check for updates, on the Subscriptions tab, press , and then tap **Refresh**.

Reading a Story

1. Press  and then tap  > **News**.
2. On the Subscriptions tab, tap a channel whose stories you want to read.
3. Scroll through the list of stories, and then tap a story to read it.
4. While reading a story, you can tap:
 -  and  to go to the previous or next story in the channel.
 -  to go back to the stories list.
 -  to share the story via a message (link to the story only) or email.
 -  to delete the story from the stories list.
5. If you want to read the whole story, tap **Read full article**. This opens the story in the Web browser. See “Navigating on a Web Page” to learn how to navigate on the Web page.

Starring a Story



Star your favorite stories to make it easy to come back to them.

1. Press  and then tap  > **News**.
2. On the Subscriptions tab, tap the channel where the story you want to star is located.
3. Do one of the following:
 - Locate the story, and then tap .
 - Tap the story you want to star to open it, and then tap  near the top-right corner of the screen.

You can remove the star from an story by tapping .



Adding a Keyword

Find stories the interest you easier by creating keywords. Stories that contain the keyword are grouped together making it easier to find the story you want.

1. Press  and then tap  > **News**.
2. On the Keywords tab, tap **Add keywords**.
3. Enter the keyword, and then tap **Done**.
4. In the Keywords tab, tap a keyword to show the stories that contain the keyword in their text.

Adding the News Widget

Read snippets of stories that you have subscribed to right on the Home screen.

1. Press  and then tap  > **Widget** > **News**.
2. Choose the widget style, and then tap **Select**.
3. Select the channel whose stories you want to read on the widget.

Drag the widget to a blank space on the Home screen, and then release.



Sprint Mobile Hotspot



Sprint Mobile Hotspot turns your device into a wireless router and shares your device's data connection (1xRTT, Sprint 3G, or Sprint 4G) with one or more computers or mobile devices using Wi-Fi. When you open Sprint Mobile Hotspot, your device creates a secure Wi-Fi network that you can connect to with your computer and access the Internet.

To use your device as a wireless router, make sure that your device has an active connection with the Sprint 1xRTT data network, the Sprint 3G network, or the Sprint 4G network. For more information, see “Getting Started With Data Services” and “Connecting Using Sprint 4G.”

To connect to your device's Wi-Fi network, you need a computer with built in Wi-Fi or a Wi-Fi adapter.

Setting Up Sprint Mobile Hotspot

1. Press  and then tap  > **Sprint Hotspot**.
2. Tap **OK** on the introduction screen.
3. Enter a new name in the **Router name (SSID)** text box, or use the default router name.
4. Select a network security method from the **Security** list. If you selected **WEP**, **WPA** or **WPA2**, enter a network key (password) in the **Password** box.
5. Select the **Sprint Mobile Hotspot** check box at the top of the screen to turn on the wireless router.

When Sprint Mobile Hotspot is active and is ready to share its 3G connection, the 3G hotspot icon () appears in the status bar. When Sprint Mobile Hotspot is active and is ready to share its Sprint 4G connection, the 4G hotspot icon () appears in the status bar.

Connecting Your Computer to Sprint Mobile Hotspot

After setting up your device as a wireless router, connect your computer to your device's Sprint Mobile Hotspot and access the Internet.

For a Windows Vista computer

1. Click **Start** > **Connect To**.
2. In the **Connect to a network** dialog box, select the Sprint Mobile Hotspot name (or SSID), and then click **Connect**.

Note: Your device's wireless network may not show up in the list of available networks immediately. Wait for a moment and then refresh the list to see the wireless network.

3. Enter the network key (if any) that you used when setting up Sprint Mobile Hotspot and then click **Connect**.
4. Click **Close**.

For a Windows XP computer



1. Click **Start > Connect To > Wireless Network Connection.**
2. In the **Choose a Wireless Network** dialog box, select the Sprint Mobile Hotspot name (or SSID), and then click **Connect.**

Note: Your device's wireless network may not show up in the list of available networks immediately. Wait for a moment and then refresh the list to see the wireless network.



3. Enter the network key (if any) that you used when setting up Sprint Mobile Hotspot and then click **Connect.**

Managing Sprint Mobile Hotspot

You can set the number of computers or devices or allow only specific devices to connect and use Sprint Mobile Hotspot to connect to the Internet.

1. Press  and then tap  > **Sprint Hotspot.**
2. Tap **OK** on the introduction screen.
3. Tap **User Management**, and then set the following options:
 - **Allowed users only:** Select this option if you want only those devices listed in the **Allowed users** list to connect to and use a Sprint Mobile Hotspot on your device.
 - **Max. connections:** Tap to set the maximum number of devices that can connect to and use Sprint Mobile Hotspot on your device.
 - **Allowed users:** Lists the MAC addresses of computers and devices that are allowed to connect to and use a Sprint Mobile Hotspot on your device.
 - **Block users:** Lists the MAC addresses of computers and devices that are not allowed to connect to and use Sprint Mobile Hotspot on your device. Tap an entry to add a computer or device that you want to block

Turning Off Sprint Mobile Hotspot

1. Press  >  and then tap **Settings > Wireless & network .**
2. Clear the **Sprint Hotspot** check box to turn off Sprint Mobile Hotspot.

Adding Sprint Mobile Hotspot Widget

Add Sprint Mobile Hotspot widget to the Home screen to make it faster for you to turn Sprint Mobile Hotspot on or off.

To learn how to add widgets, see “Customizing the Home Screen” on page 23.

Using Your Device as a Modem (Internet Sharing)

Get online with your notebook or desktop computer at any time, using your device's data connection. For information on setting up and using the data connection, see "Getting Started With Data Services."

Note: You need to install HTC Sync before you can use your phone as a modem. See "HTC Sync" on page 65 for details.

Make sure that your device has an active connection with the Sprint 1xRTT data network or the Sprint 3G network. For more information, see "Getting Started With Data Services."

1. Connect the device to the computer using the provided USB cable.
2. On the Connect to PC screen, select **Internet sharing**, and then tap **Done**.

When you are using your device as a modem, the USB mass storage feature is disabled, and you will not be able to use HTC Sync.

Data Services FAQs



How will I know when my device is ready for data service?

Your user name (for example, bsmith01@sprintpcs.com) will be displayed when you access **Settings > About phone > Network > Current username**.

How do I sign in for the first time?

You are automatically signed in to access data services when you turn on your device.



How do I know when my device is connected to data services?

Your device automatically connects when you use data service or an incoming message arrives. You will also see the  or  indicator.

Can I make calls and use data services at the same time?

You cannot use voice and data services simultaneously. If you receive a call while data service is active, your device forwards the call to voicemail. You can place an outgoing call anytime, but it will interrupt any in-progress data session.

When is my data connection active?

Your connection is active when data is being transferred. Outgoing calls are allowed; incoming calls go directly to voicemail. When active, the  or  indicator animates on your device's display screen.

When is my data connection dormant?

If your device receives no data for ten seconds, the connection goes dormant. When the connection is dormant, you can make and receive voice calls. (The connection may become active again quickly.) If your device receives no data for an extended period of time, the connection will terminate.

Can I sign out of data services?

You can sign out without turning off your device; however, you will not be able to browse the Web or use other data services (unless you establish a Wi-Fi connection.) While signed out, you can still place or receive phone calls, check voicemail, and use other voice services. You may sign in again at any time. To sign out, go to **Settings > Wireless & networks** and clear the **Mobile network** check box.

3C. Entertainment: TV and Music

- ◆ TV (page 148)
- ◆ Music - MP3 Store (page 150)
- ◆ Streaming Music (page 150)
- ◆ YouTube (page 151)
- ◆ NASCAR Sprint Cup Mobile (page 152)

TV

Sprint TV gives you the ability to listen to audio clips and to view video clips right from your device's display. Watch live TV and catch up on episodes of your favorite shows – anywhere on the Nationwide Sprint Network.

Your Sprint TV Channel Options



The Sprint TV application offers a wide variety of accessible channels. Subscription options include comprehensive basic packages as well as a full menu of “a la carte” channels. Visit www.sprint.com for more information on channels and pricing.

Some of the available categories may include:

- Sprint Radio
- Sprint Power View
- Primetime TV
- Music Videos
- Sprint TV Live
- Music & Radio
- Sports
- Entertainment
- Cartoons
- News & Weather
- Movies & Shorts
- Mobile Previews

Note: Available categories and content are subject to change.

Watching TV

1. Press  and tap  > **SprintTV**.
2. Select **TV**, **Favorites**, or **More** to display channel options.
3. Tap a channel from the Sprint TV listings or to select an available category.

Note: The first time you access a channel, the system will prompt you to purchase access (unless the channel doesn't have a monthly fee). Select **Subscribe** to purchase access, or select **Preview** to view a preview of the selected channel.

4. If applicable, tap the clip to view the program. The clip will automatically load and begin playing.

Note: You must turn off Wi-Fi before you can view Sprint TV. If you launch Sprint TV and have Wi-Fi enabled, a message will appear onscreen asking you if you want to turn off Wi-Fi.

Tip: While you are playing a clip, you can slide your finger up or down on the screen to surf to a different channel. You will see a small pop-up screen that tells you which channel you are watching as well as other channels that you have access to. Slide your finger on the screen to scroll through the channels. Once you find a channel that you want to watch or listen to, scroll to it and then tap it (or simply wait approximately three seconds), and the channel will begin loading.

TV FAQs

1. Will I know if I'm receiving an incoming call while I'm viewing or listening to a media clip?

No. All incoming calls will roll into voicemail while you are playing a clip. If the caller leaves a voicemail, you will see the voicemail icon on the screen.

2. How long are the clips? Will I know the estimated time it will take to play the clip prior to accessing it?

Once you have selected a channel, you will see a listing of the available clips, with each clip's length displayed after the clip's title. In general, a clip's duration will depend on the story or content being provided, and can be fairly short or as long as a few minutes.

3. Can I access a clip wherever I am, as long as I have my device?

As long as you are on the Nationwide Sprint Network, you will have access to the audio and video clips.

Note: Sprint TV service does not work while roaming off of the Nationwide Sprint Network or where service is unavailable.

4. Are the videos that I'm viewing "live" videos?

It depends on the content provider. Some of the channels available through Sprint TV stream live content. Others provide media on demand with video and audio clips that are refreshed throughout the day, but that are not "live."

5. After purchasing access to an Available Channel for a monthly fee, do I receive any confirmation? That is, how do I know it has been purchased?

The next time you access the channel, you bypass the Preview/Purchase page and go directly to the available content.

6. If I don't subscribe to a data plan, will I still be able to view the multimedia clips?

Yes. For service access charges, please consult your Sprint service plan or visit www.sprint.com.

7. What does it mean when the video pauses and I see the word "loading" at the bottom of the screen?

This happens when the device is loading the data necessary to play the clip. It typically occurs when there is heavy traffic on the network.

8. How can I cancel service if I decide I don't want it?

To cancel your Sprint TV service, visit www.sprint.com and sign on to **My Sprint** with your account number and password. From this page, you have the ability to cancel the service or any channels to which you subscribe.

9. If I put on my stereo headset and insert it into the device's headset jack, can I turn off the screen while I am playing an audio (or video) clip without interrupting the clip?

Yes. When you insert your stereo headset into the device's headset jack, the device automatically goes into "headset mode," allowing you to turn the screen off and continue playing the clip. (Likewise, if your device is in "headset mode," a phone call will not disconnect when you turn off the screen.)

10. Can I surf to a different channel while I am playing a clip?

Yes. While you are playing a clip, you can use the up and down navigation keys to surf to a different channel. You will see a small pop-up screen that tells you which channel you are watching as well as other channels that you have access to. Use the navigation keys to scroll through the different channels. Once you find a channel that you want to watch, scroll to it and press (or simply wait approximately three seconds), and the channel will begin loading.

Music - MP3 Store

MP3 Store lets you preview, purchase, download, and listen to over a million songs right on your device. MP3 Store provides you with one-touch access to digital music from www.amazon.com. Amazon has more than 6 million DRM-free MP3 tracks you can purchase and download to your device.

Important: You can download MP3s only by using a Sprint 4G or Wi-Fi connection. You can browse and preview songs using a data connection.

Accessing MP3 Store

▶ Press  and tap  > **MP3 Store**.

Purchasing and Downloading Music

Now that you're in the store, you can shop for songs to purchase and download to your device's microSD card.



1. From the Amazon MP3 opening page, select an option to browse the store:
 - **Top 100 Albums** displays the top 100 albums on Amazon.
 - **Top 100 Songs** displays the top 100 songs on Amazon.
 - **Browse by Genre** lets you search songs or albums by musical genres.
 - **Search** gives you the option of searching for specific songs, albums, or artists. Just use the onscreen keyboard to enter your search criteria in the available box and tap .
2. Tap the price at the right side of the album or song to purchase it.
3. Tap **Buy**. (If there is no microSD card installed or if there is not enough free memory space on the card, you will see an alert.)
4. Enter your **Amazon.com account e-mail address** and **Password**, and tap **OK**.

Tip: While viewing a song list, preview the song by tapping the song name in the list.

While viewing an album list, tap an album to display the songs included in the album. You can purchase individual songs in an album.

Streaming Music

In addition to the Amazon MP3, Sprint offers a variety of musical options through the Radio category in the Sprint TV menu, including SIRIUS Music, Music Choice, VH1, and many others. Choose from rock, pop, hip-hop, and R&B, and access exclusive video clips, music industry news, performances, and interviews with your favorite artists.

1. Press  and tap  > **Sprint TV**.
2. Select **Radio** to display channel options.
3. Tap a channel from the Sprint TV listings or to select an available category.
4. Select **Preview** to see and hear a preview of your selected channel (if available).
– or –
Select **Subscribe** to purchase a monthly subscription to your selected channel.

Once you have purchased access to a music or radio channel, you can select from a variety of stations to listen to your favorite music or get caught up on what's new in music.



YouTube

YouTube is an online video streaming service that allows you to view videos that have been uploaded by YouTube members.

Note: You do not need a YouTube account to browse and view videos. However, to use all the features of YouTube (such as viewing “My account”), you must create a YouTube account from your computer and sign in to that account from your device.

You must have an active data, Sprint 4G or Wi-Fi connection to access YouTube.

Opening YouTube

► Press  and tap  > **YouTube**. (You may need to scroll down the screen to see the icon.)

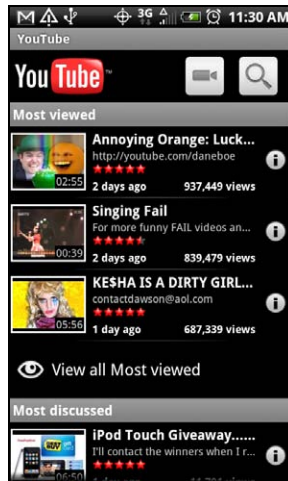



YouTube presents the videos grouped into categories, such as **Most viewed**, **Most discussed**, **Most recent**, and **Top rated**.



Watching Videos

1. On the YouTube screen, select a video to watch from the available categories. Tap a category to see the available videos for that category.
2. Tap a video to play it.

Note: The screen automatically switches to landscape orientation when you play a video.

3. While watching a video:
 - Tap the screen to display the playback controls. When the playback controls are displayed, you can pause, skip forward or backward, or drag the slider to the point in the video you want to watch.
 - Press  to rank, comment on, share, flag as inappropriate, and interact with the video in other ways.
4. Press  to stop playback and return to the videos list.

Searching for Videos

1. On the YouTube screen, press .
2. Enter a search keyword and press  again.
3. Tap a search result. The number of search results appears below the status bar.
4. Scroll through the videos and tap a video to watch it.

To clear the search history:

1. On the YouTube screen, press  and tap **Settings**.
2. Tap **Clear search history** and tap **OK**.





Sharing Videos

You can share a video by sending its link to your contacts.

1. While viewing videos in a list, press and hold the video, and then tap **Share** on the options menu.
– or –
While watching a video, press  and tap **Share**.
2. Select how you want to share the video link.
3. Follow screen instructions to send the video link to your contacts.

Capturing a Video and Sharing it on YouTube

You need to be signed in to your Google Account to upload your video to YouTube.



1. On the YouTube screen, tap .
2. Tap **Camera** and then tap  to start capturing video. When you are done capturing, tap .
– or –
Tap **Qik**, and then tap  to start capturing video. When you are done capturing, tap .

Note: To upload videos to YouTube using Qik, you need to be signed in to your Qik account. For more information, see “Sharing Live Videos with Qik” on page 88.

You need to set up your Qik account to upload videos directly to YouTube. For more information, visit <http://qiksupport.pbworks.com> and click **Video Sharing Issues**.

3. Follow screen instructions or tap the appropriate screen buttons to enter a title, description, or tags for your video, or set the privacy level.
4. Tap **Upload**.

Closing YouTube

- ▶ While on the YouTube screen, press  or .

NASCAR Sprint Cup Mobile

NASCAR Sprint Cup MobileSM keeps all NASCAR related information in one convenient location on your device and enables you to personalize the content with your favorite driver. When you are away from the track, you can follow races using streaming MRN/PRN race broadcast coverage and in-car audio. NASCAR Sprint Cup Mobile delivers real-time, race-day statistics and telemetry from all 43 NASCAR Sprint Cup SeriesTM drivers and offers video on demand from NASCAR.COM, SPEED and more.

NASCAR Sprint Cup Mobile provides the following features:



- Personalize the program view to track your favorite driver
- Live MRN/PRN race broadcasts
- Live driver/team audio communications
- Real-time race-day statistics and telemetry for all 43 NASCAR Sprint Cup Series drivers

- 24-hour access to breaking NASCAR Sprint Cup Series news including insight and analysis from industry experts
- Delivers race and qualifying results including NASCAR Sprint Cup Series points standings and season statistics
- Offers video on demand from NASCAR.COM, SPEED programming and more

Note: While using this program, incoming calls may go directly to voicemail.

Using NASCAR Sprint Cup Mobile for the First Time

When you open NASCAR Sprint Cup Mobile for the first time, it will prompt you to specify your favorite NASCAR driver.

1. Press  and tap  > **NASCAR Sprint Cup Mobile**. (You may need to scroll down the screen to see the icon.)
2. On the welcome screen, tap the **Car# or Driver name** box. On the subsequent screen, enter your favorite NASCAR car number or driver name and then tap **OK**. Tap **Go** to continue.
– or –
You can also tap **Select from a list** and then tap a NASCAR driver.
3. A message is then displayed, confirming whether to add your favorite NASCAR driver to your **My Drivers** list. Tap **YES** to add.
4. If there are subsequent screens that are displayed, read the messages on the screens and select your preferences. Tap **OK** to proceed to the NASCAR Home screen.

The NASCAR Sprint Cup Mobile Home Screen

Whenever you open NASCAR Sprint Cup Mobile, the NASCAR Home screen will be displayed, showing your favorite NASCAR driver banner with statistics. Swipe your finger upward to scroll down the screen and browse through more content.

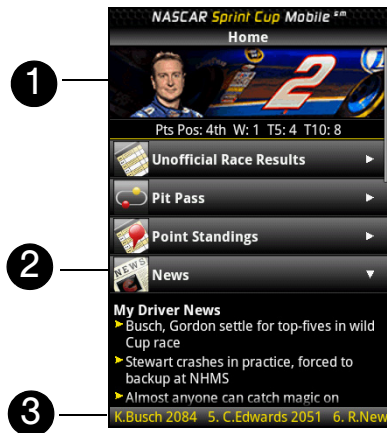

1. **Driver banner.** Shows your favorite NASCAR driver with key statistics. Tap the banner to view the driver profile.
2. **Drawer.** Information on the NASCAR Home screen is organized into several drawers. When a drawer is open, it shows a down arrow at the right side of the drawer. Tap to close the drawer. To view information in another drawer, tap the drawer to open it.
3. **Ticker.** Shows breaking news ticker.

Note: The NASCAR Home screen looks different on race days and non-race days below the driver banner.

The Menu Bar











Press  to display the Menu Bar and access more features of the NASCAR Sprint Cup Mobile.



Navigating the Menu Bar

1. Drag your finger left or right across the Menu Bar to scroll through the available feature.
2. Tap an icon to select it and display the corresponding information.

Menu Bar Icons

<i>Icon</i>		<i>Description</i>
	Home	Returns you to the NASCAR Home screen.
	My Driver	Displays your favorite driver's profile, season and race statistics, news and downloads.
	News	Displays current driver and racing news as well editorial and recent race photos.
	Stats & Schedules	Includes race results, point standings, and season statistics. The NASCAR season schedule is included here as well.
	NASCAR on SPEED	View live SPEED programming or recorded video.
	Audio/Video	Gives you access to the most recent NASCAR video and audio clips.
	Sprint FanZone	Learn about the latest Sprint promotions, and see the recent winners in the Sprint All-Star Sweepstakes.
	Fantasy	View NASCAR Fantasy league-related articles and videos.
	Alerts & Personalization	Allows you to: <ul style="list-style-type: none"> ● Change your primary favorite driver ● Add or delete any of the four secondary favorite drivers ● Subscribe and unsubscribe to free Sprint Cup SMS text alerts ● Set your default in-car audio
	Help	Displays the NASCAR Sprint Cup Mobile Help.
	Exit	When you want to close the program, select Exit , and then tap YES .

3D. GPS Navigation



- ◆ GPS Services (page 155)
- ◆ Sprint Navigation (page 155)
- ◆ Google Maps (page 156)
- ◆ Google Latitude (page 160)
- ◆ Footprints (page 163)

GPS Services

Your device's built-in GPS capability gives you access to a number of location-based services, including **Sprint Navigation**, **Google Maps**, and **Footprints**.

Activating Location Mode

Before using any of the location-based services, you must turn on your device's location mode.

1. Press  > , tap **Settings** > **Location**, and then tap **Location setting**. (You will see the Location disclaimer.)
2. Read the disclaimer, select **ON** and press .



Sprint Navigation

Sprint Navigation gives you turn-by-turn directions onscreen and over speakerphone.



Note: Depending on your service plan, Sprint Navigation may require a monthly subscription. Contact Sprint for information and pricing.

Registering Sprint Navigation

Before you can use Sprint Navigation, your device and service must be registered.

1. Press  and tap  > **Sprint Navigation**.
2. Follow the onscreen instructions to enter and submit the required information.

Using Sprint Navigation

1. Press  and tap  > **Sprint Navigation**.
2. Select an option and follow the onscreen instructions to get directions or view maps.
 - **Drive To** lets you enter an address (vocally or using the keypad) or select from categories such as My Favorites, Recent Places, or Businesses to search for turn-by-turn directions.
 - **Search** provides a categorized list of locations such as Gas Stations, Grocery Stores, and Hospitals to help find local businesses and services.
 - **Maps & Traffic** lets you view maps and get traffic information for your current location or for any other location (same categories as Drive To).
 - **Share & More** provides access to additional services such as Record Location, Product Tour, and Preferences.

Note: For more information about Sprint Navigation, visit www.sprint.com/navigation.

Google Maps

Google Maps lets you track your current location, view real-time traffic situations, and receive detailed directions to your destination. It also provides a search tool where you can locate places of interest or an address on a vector or aerial map, or view locations in street level.

Note: You need an active 3G, 4G, or Wi-Fi connection to use Google Maps.

Google Maps does not cover every country or city.

Enabling Location Source

Before you open Google Maps and find your location or search for places of interest, you must enable **My location sources**.

1. Press Press  >  and tap **Settings > Location**.
2. Select **Use wireless networks**, **Use GPS satellites**, or both.

Note: Selecting **Use GPS satellites** lets you locate places of interest at street level. However, this requires a clear view of the sky and more battery power.

Opening Google Maps

▶ Press  and tap  > **Maps**.

To find your location on the map:

▶ While on the Google Maps screen, press  and tap **My Location**. Your location is shown on the map as a blinking blue dot.

To move on the map:

Swipe your finger on the screen to view other areas of the map.

To zoom in or out of a map:

Tap  to zoom in; tap  to zoom out.

To get an address and additional information for a location

Press and hold a location on the map. A balloon opens over the location, with the address and a thumbnail from street view (if available). Tap the balloon to see more information or to get directions to that location.

To look at a location in Street View:

Street View mode (available only in selected areas) provides a street-level view of the location.

1. Do one of the following:
 - Press and hold a location on the map, and then tap the balloon that appears.
 - Search for the place you want to view in Street View. For more information, see “Searching for Places of Interest.” When you find the place, tap its balloon.
2. On the location details screen, tap **Street view**.

- To navigate in Street View, do any of the following:
 - Swipe your finger on the screen to pan up or down or to look in other directions.
 - Tap the displayed arrows to move up and down the street.
 - Press  to select from other navigation options.

Note: While viewing a Street View of a location, press  and then tap **Compass mode** to turn Compass mode on. Tilt, pan, or turn your device to view the area around the selected location.

To clear the map:

After you get directions or search on a map (as described in the other parts of this section), you can clear away the various markers on the map.

When viewing a map, press  and then tap **More > Clear map**.

Viewing Map Layers

Initially, Google Maps opens with a street map. You can view additional map layers, such as satellite images, traffic information, your Google Latitude friends' locations, and Wikipedia information on locations. You can also view maps that you and other people have created in Google Maps on the Web.

Tip: Multiple layers can be viewed at the same time.

Not all locations have information to support all Map layers or all zoom levels. To learn more about layers, visit Google Maps on the Web: <http://maps.google.com>

- While viewing a map, press , and then tap **Layers**.
- Select any of the following:
 - **Traffic:** (available only in selected areas) Real-time traffic conditions are displayed over roads as color-coded lines. Each color represents how fast the traffic is moving.

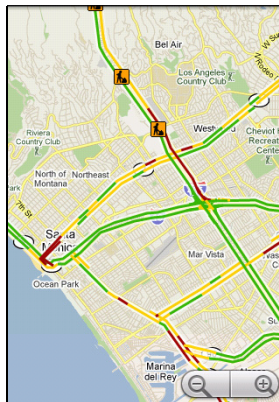

- **Satellite:** Google Maps uses the same satellite data as Google Earth™. Satellite images are not real-time. Google Earth acquires the best imagery available, most of which is approximately one to three years old.

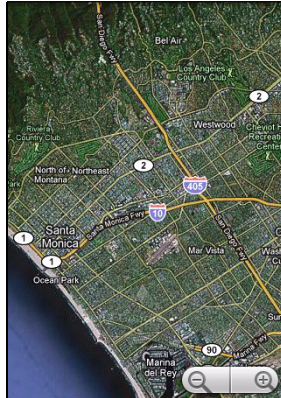

- **Buzz:** Displays information and photos of a location or place which you or your friends have posted. With Google Buzz you can share a tip, make a recommendation, post a photo, or find out what other people are talking about on a particular location, such as an upcoming traffic jam or a concert — all while viewing a map.
- **Latitude:** When you have joined Latitude, you can view your friends' locations as a layer on the map. For information, see “Google Latitude” in this chapter.
- To select more layers such as transit lines or maps that you have created in Google Maps on the Web, tap **More layers**.
- To clear layers and view only the street map, tap **Clear map**.

Searching for Places of Interest

1. While on the Google Maps screen, press .
2. Enter the place you want to search in the search box. You can enter an address, a city, or type of business or establishment (for example, pizza).

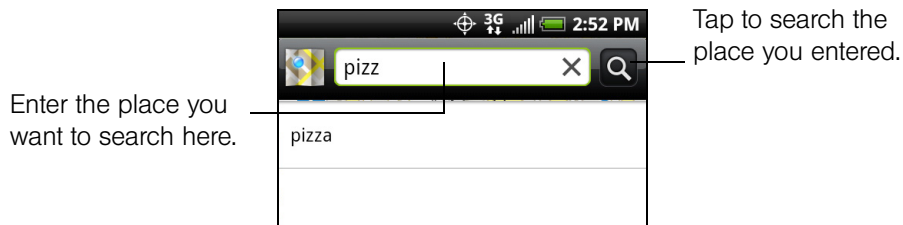



Note: After entering your search item, you may be asked to choose the place you want to search.

Tip: As you enter information, a list of all the places which you have searched or visited before as well as the addresses of your contacts (if specified) appear on the screen. You can also tap an address on the menu to show its location on the map.

3. Tap . The search results are displayed on the map.



Tip: Tap  to go to the next search item on the map if there are multiple search results.

Tap  to show the search results as a list.

4. Tap the callout to show the **Address**, **Details** (if available), and **Reviews** (if available) for the search item.

Getting Directions

Use Google Maps to get detailed directions to your destination.

1. While viewing a map in any mode, press  and tap **Directions**.
2. Enter the starting point in the first text box, and then enter your destination in the second text box. By default, your current location is entered in the **Start point** box.

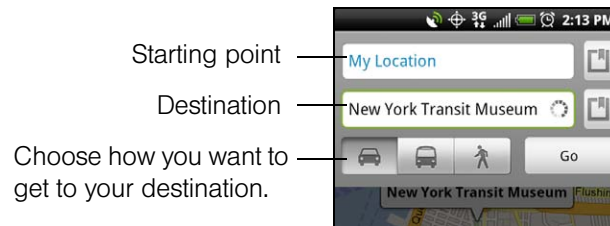

You can also tap  to open the location source menu and select a starting point and destination address.

3. Choose how you want to get to your destination: **Driving**, **Public transit**, or **Walking**.

4. Tap **Go**. The directions to your destination appears in a list. Tap a direction instruction on the list to show the map.

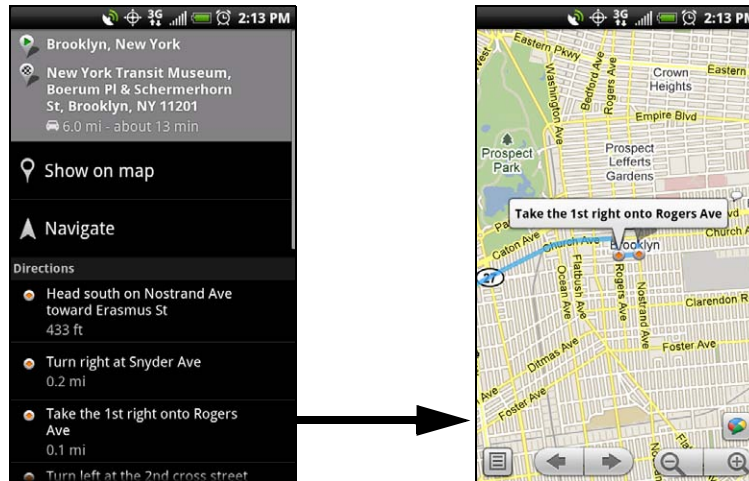

When you are finished viewing or following the directions, press  and tap **More > Clear Map** to reset the map. Your destination is automatically saved in the Google Maps history.

Google Latitude

Google Latitude™ user location service lets you and your friends share locations and status messages with each other. It also lets you send instant messages and emails, make phone calls, and get directions to your friends' locations.

Your location is not shared automatically. You must join Latitude, and then invite your friends to view your location or accept their invitations.

Opening Latitude

To join Latitude:

1. While viewing a map in any mode, press  and then tap **Join Latitude**.
2. Read the privacy policy. If you agree with it, tap **Agree & share**.

After you join Latitude, you can start sharing your locations with your friends. Only friends that you have explicitly invited or accepted can see your location.

To open Latitude after joining:

- ▶ While viewing a map in any mode, press  and then tap **Latitude**.

Inviting Friends

To share your location with friends and request to see their locations:

1. In Latitude, press  and then tap **Add friends**.
2. Choose how to add friends:
 - **Select from Contacts**. Select any number of friends from People.
 - **Add via email address**. Enter an email address.

3. Tap **Add friends** > **Yes**.

If your friends already use Latitude, they receive an email request and a notification on Latitude. If they have not yet joined Latitude, they receive an email request that tells them to sign in to Latitude with their Google account.

Accepting an Invitation

When you get a sharing request from a friend, you can:

- **Accept and share back.** You can see your friends' locations, and they can see yours.
- **Accept, but hide my location.** You can see your friends' locations, but they can't see yours.
- **Don't accept.** No location information is shared between you and your friends.

You can change how your location is shared with each friend at any time. See "Inviting Friends" for details.

Showing Your Friends

You can show your friends using the map view or the list view.

Map View

When you open Google Maps™, it shows your friends' locations. Each friend is represented by a photo icon with an arrow pointing at his or her approximate location. If a friend has opted to enable city-level sharing, his or her icon will not have an arrow and it appears in the middle of the city. See "Inviting Friends" for more details.

To see your friend's profile and connect with him or her, tap the photo. This will display your friend's name, and then tap the balloon right above his or her icon.

To see other friends, tap either one of the arrow buttons next to the balloon.

List View

To show a list of your friends, in Google Maps, press  and then tap **Latitude**.

To see a friend's profile and connect with him or her, select your friend's name from the list.

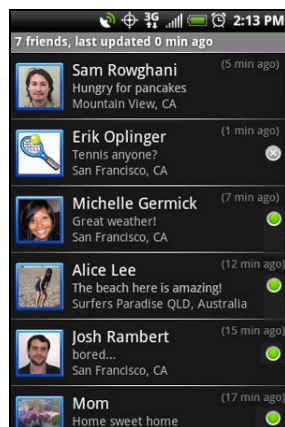

List view



Map view

Connecting with Your Friends

Tap a friend's contact details balloon in map view or tap a friend in list view to open the friend's profile. In the profile screen, you can communicate with your friend and set privacy options.

- **Show on map:** Find a friend's location on the map.
- **Chat using Google Talk:** Send an instant message. Google Talk opens a chat window with that friend.
- **Send email:** Send an email. Gmail opens an email addressed to that friend.
- **Get directions:** Get directions to the friend's location.
- **Sharing options:** Select from the following:
 - **Share best available location:** Share your precise location information.
 - **Share only city level location:** Share only the city you are in, not the street-level location. Your friend can see your photo icon in the middle of the city you are in. To share more precise location again, tap **Best available location**.
 - **Hide from this friend:** Stop sharing your location with this friend, in a list or on a map.
- **Remove this friend:** Remove the friend from your list and stop sharing locations with him or her altogether.

Changing Privacy Settings

You have control over how and when you can be found by your friends. Only the last location sent to Latitude is stored with your Google account. If you turn off Latitude or are hiding, no location is stored.

To change your public profile:



1. In Google Maps, press  and tap **Latitude**.
2. Tap your own name, and then tap **Edit privacy settings**.
3. Set the following options to your preferences.
 - **Detect your location:** Let Latitude detect and update your location as you move. The update frequency is determined by several factors, such as how recently your location has changed.
 - **Set your location:** Choose from several options to manually select your location.
 - **Hide your location:** Hide your location from all your friends.
 - **Turn off Latitude:** Disable Latitude and stop sharing your location or status. You can always join Latitude again.

Footprints

Footprints™ provides an easy way to record favorite places and revisit those places. A footprint consists of a photo you take of a location such as a restaurant or sightseeing destination stored together with a precise GPS position and other information about that location such as the street address and phone number.

The next time you want to visit the same place, simply access the footprint. You can then dial the phone number or view the location in Google Maps.

Creating a Footprint

1. Press  and tap  > **Footprints**.
2. Tap **New footprint**. If GPS is not on, you are prompted to turn it on so that your device can use GPS to find your location.

Note: **My Location sources** options in **Settings** need to be selected to be able to determine your GPS location. You will be asked to turn them on if the options are turned off.

3. Point the camera at the scene you want to show the location. Footprints starts to use GPS to search for your position.

Tip: To change brightness and white balance settings before you take a photo, press , tap **Brightness** or **White Balance**, and then choose a setting.

4. Tap  to capture the photo.



Note: If your GPS position has not been found yet, you are asked whether to find the position on Google Maps, continue the GPS search, or stop the GPS search.

You may be asked if you want Footprints to automatically determine the address for the location.

5. Tap **Done**.

Note: Before pressing **Done**, you can press , and then tap **Edit** to change the name, category, or address of the Footprint, enter the phone and website, and add a voice memo to the Footprint.

Revisiting a Footprint

1. Press  and tap  > **Footprints**.
2. At the bottom of the screen, slide your finger to select the Footprint category.
3. Tap the Footprint you want to revisit.

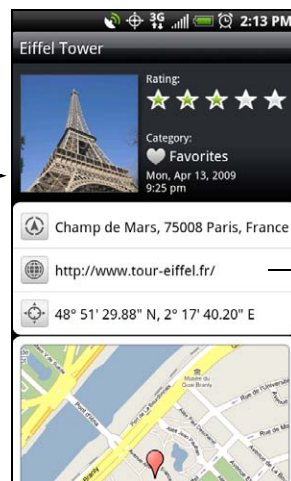
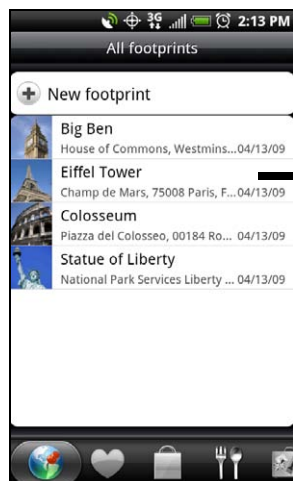

Tap to show the address in Google Maps.







Tap to open the URL in the browser.

Editing or Deleting a Footprint

On a category screen, press and hold the Footprint you want to edit or delete, and then tap **Edit** or **Delete** on the options menu.

Exporting your Footprints



You can back up footprints by exporting them to a storage card. You can also open exported footprints files in other applications such as Google Earth on your PC. To transfer files from your storage card to your computer, see “Using the Device’s microSD Card as a USB Drive” on page 74.

- ▶ Press  and tap  > **Footprints**, and then do any of the following:
 - To export all your footprints, on the All footprints tab , press  and tap **Export**.
 - To export all the footprints from a particular category, while viewing that category, press  and tap **Export**.
 - To export a single footprint, open the footprint, press  and tap **Export**.

Exported footprints are saved as **.kmz** files in the Footprints_Data folder on your storage card. If you exported multiple footprints at one time, they are saved together in one **.kmz** file.

Importing Footprints

You can restore footprints you previously backed up to the storage card. You can also import **.kmz** files that you saved in other applications, or use a photo as a footprint.

1. Press  and tap  > **Footprints**.
2. Press  and tap **Import**.
3. Do one of the following:
 - To import a photo, tap **Picture**, navigate to the photo you want to import, and then tap the photo. You can then add Footprints information such as location and category.
 - To import saved footprints or another **.kmz** file from the storage card, tap **Footprints data**, and then tap the file you want to import. If a footprint on the device is the same as one you want to import, you are asked whether you want to overwrite it.

Adding the Footprints Widget

Add the Footprints widget to view and access your footprints on the Home screen. To learn how to add widgets, see “Customizing the Home Screen” on page 23.

Section 4
***Safety and
Warranty Information***



4A. Important Safety Information

- ◆ Important Health Information and Safety Precautions (page 166)
- ◆ General Precautions (page 170)
- ◆ Additional Safety Information (page 172)

This User Guide contains important operational and safety information that will help you safely use your device. Failure to read and follow the information provided in this guide may result in serious bodily injury, death, or property damage.

Important Health Information and Safety Precautions

When using this product, the safety precautions below must be taken to avoid possible legal liabilities and damages.

Retain and follow all product safety and operating instructions. Observe all warnings in the operating instructions on the product.

To reduce the risk of bodily injury, electric shock, fire, and damage to the equipment, observe the following precautions.

Electrical Safety

This product is intended for use when supplied with power from the designated battery or power supply unit. Other usage may be dangerous and will invalidate any approval given to this product.

Safety Precautions for Proper Grounding Installation

CAUTION: Connecting to an improperly grounded equipment can result in an electric shock to your device.

This product is equipped with a USB cable for connecting with desktop or notebook computer. Be sure your computer is properly grounded (earthed) before connecting this product to the computer. The power supply cord of a desktop or notebook computer has an equipment-grounding conductor and a grounding plug. The plug must be plugged into an appropriate outlet which is properly installed and grounded in accordance with all local codes and ordinances.

Safety Precautions for Power Supply Unit

- Use the correct external power source
A product should be operated only from the type of power source indicated on the electrical ratings label. If you are not sure of the type of power source required, consult your authorized service provider or local power company. For a product that operates from battery power or other sources, refer to the operating instructions that are included with the product.
- Handle battery packs carefully
This product contains a Lithium-ion polymer or Lithium-ion battery. There is a risk of fire and burns if the battery pack is handled improperly. Do not attempt to open or service the battery pack. Do not disassemble, crush, puncture, short external contacts or circuits, dispose of in fire or water, or expose a battery pack to temperatures higher than 140°F (60°C).

WARNING: Danger of explosion if battery is incorrectly replaced. To reduce risk of fire or burns, do not disassemble, crush, puncture, short external contacts, expose to temperature above 60°C (140°F), or dispose of in fire or water. Replace only with specified batteries. Recycle or dispose of used batteries according to the local regulations or reference guide supplied with your product.



Take Extra Precautions

- Keep the battery or device dry and away from water or any liquid as it may cause a short circuit.
- Keep metal objects away so they don't come in contact with the battery or its connectors as it may lead to short circuit during operation.
- The phone should only be connected to products that bear the USB-IF logo or have completed the USB-IF compliance program.
- Do not use a battery that appears damaged, deformed, or discolored, or the one that has any rust on its casing, overheats, or emits a foul odor.
- Always keep the battery out of the reach of babies and small children, to avoid swallowing of the battery. Consult the doctor immediately if the battery is swallowed.
- Only use the battery with a charging system that has been qualified with the system per this standard, IEEE-Std-1725-2006. Use of an unqualified battery or charger may present a risk of fire, explosion, leakage or other hazard.
- Replace the battery only with another battery that has been qualified with the system per this standard, IEEE-Std-1725-2006. Use of an unqualified battery may present a risk of fire, explosion, leakage or other hazard.
- Avoid dropping the phone or battery. If the phone or battery is dropped, especially on a hard surface, and the user suspects damage, take it to a service centre for inspection.
- If the battery leaks:
 - Do not allow the leaking fluid to come in contact with skin or clothing. If already in contact, flush the affected area immediately with clean water and seek medical advice.
 - Do not allow the leaking fluid to come in contact with eyes. If already in contact, DO NOT rub; rinse with clean water immediately and seek medical advice.
 - Take extra precautions to keep a leaking battery away from fire as there is a danger of ignition or explosion.

Safety Precautions for Direct Sunlight

Keep this product away from excessive moisture and extreme temperatures. Do not leave the product or its battery inside a vehicle or in places where the temperature may exceed 60°C (140°F), such as on a car dashboard, window sill, or behind a glass that is exposed to direct sunlight or strong ultraviolet light for extended periods of time. This may damage the product, overheat the battery, or pose a risk to the vehicle.

Prevention of Hearing Loss

CAUTION: Permanent hearing loss may occur if earphones or headphones are used at high volume for prolonged periods of time.

Safety in Aircraft

Due to the possible interference caused by this product to an aircraft's navigation system and its communications network, using this device's phone function on board an airplane is against the law in most countries. If you want to use this device when on board an aircraft, remember to turn off your phone by switching to airplane mode.

Environment Restrictions

Do not use this product in gas stations, fuel depots, chemical plants or where blasting operations are in progress, or in potentially explosive atmospheres such as fuelling areas, fuel storehouses, below deck on boats, chemical plants, fuel or chemical transfer or storage facilities, and areas where the air contains chemicals or particles, such as grain, dust, or metal powders. Please be aware that sparks in such areas could cause an explosion or fire resulting in bodily injury or even death.

Explosive Atmospheres

When in any area with a potentially explosive atmosphere or where flammable materials exist, the product should be turned off and the user should obey all signs and instructions. Sparks in such areas could cause an explosion or fire resulting in bodily injury or even death. Users are advised not to use the equipment at refueling points such as service or gas stations, and are reminded of the need to observe restrictions on the use of radio equipment in fuel depots, chemical plants, or where blasting operations are in progress. Areas with a potentially explosive atmosphere are often, but not always, clearly marked. These include fueling areas, below deck on boats, fuel or chemical transfer or storage facilities, and areas where the air contains chemicals or particles, such as grain, dust, or metal powders.

Road Safety

Full attention must be given to driving at all times in order to reduce the risk of an accident. Using a phone while driving (even with a hands free kit) causes distraction and can lead to an accident. You must comply with local laws and regulations restricting the use of wireless devices while driving.

Safety Precautions for RF Exposure

- Avoid using your phone near metal structures (for example, the steel frame of a building).
- Avoid using your phone near strong electromagnetic sources, such as microwave ovens, sound speakers, TV and radio.
- Use only original manufacturer-approved accessories, or accessories that do not contain any metal.
- Use of non-original manufacturer-approved accessories may violate your local RF exposure guidelines and should be avoided.

Interference with Medical Equipment Functions

This product may cause medical equipment to malfunction. The use of this device is forbidden in most hospitals and medical clinics.

If you use any other personal medical device, consult the manufacturer of your device to determine if they are adequately shielded from external RF energy. Your physician may be able to assist you in obtaining this information.

Turn your phone OFF in health care facilities when any regulations posted in these areas instruct you to do so. Hospitals or health care facilities may be using equipment that could be sensitive to external RF energy.

Hearing Aids

Some digital wireless phones may interfere with some hearing aids. In the event of such interference, you may want to consult your service provider, or call the customer service line to discuss alternatives.

Nonionizing Radiation

Your device has an internal antenna. This product should be operated in its normal-use position to ensure the radiative performance and safety of the interference. As with other mobile radio transmitting equipment, users are advised that for satisfactory operation of the equipment and for the safety of personnel, it is recommended that no part of the human body be allowed to come too close to the antenna during operation of the equipment.

Use only the supplied integral antenna. Use of unauthorized or modified antennas may impair call quality and damage the phone, causing loss of performance and SAR levels exceeding the recommended limits as well as result in non-compliance with local regulatory requirements in your country.

To assure optimal phone performance and ensure human exposure to RF energy is within the guidelines set forth in the relevant standards, always use your device only in its normal-use position. Contact with the antenna area may impair call quality and cause your device to operate at a higher power level than needed. Avoiding contact with the antenna area when the phone is IN USE optimizes the antenna performance and the battery life.

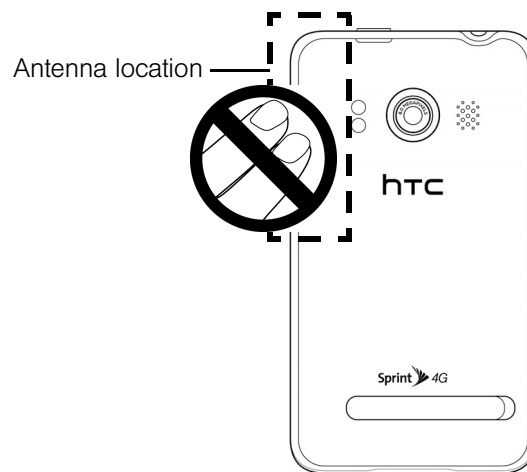

Electrical Safety

- Accessories
 - Use only approved accessories.
 - Do not connect with incompatible products or accessories.
 - Take care not to touch or allow metal objects, such as coins or key rings, to contact or short-circuit the battery terminals.
- Connection to a car
 - Seek professional advice when connecting a phone interface to the vehicle electrical system.
- Faulty and damaged products
 - Do not attempt to disassemble the device or its accessories.
 - Only qualified personnel should service or repair the device or its accessories.

General Precautions

You alone are responsible for how you use your phone and any consequences of its use. You must always switch off your phone wherever the use of a phone is prohibited. Use of your phone is subject to safety measures designed to protect users and their environment.

- **Avoid applying excessive pressure to the device.**

Do not apply excessive pressure on the screen and the device to prevent damaging them and remove the device from your pants' pocket before sitting down. It is also recommended that you store the device in a protective case and only use the device stylus or your finger when interacting with the touch screen. Cracked display screens due to improper handling are not covered by the warranty.

- **Device getting warm after prolonged use.**

When using your device for prolonged periods of time, such as when you're talking on the phone, charging the battery or browsing the Web, the device may become warm. In most cases, this condition is normal and therefore should not be interpreted as a problem with the device.

- **Heed service markings.**

Except as explained elsewhere in the Operating or Service documentation, do not service any product yourself. Service needed on components inside the device should be done by an authorized service technician or provider.

- **Protect your phone.**

- Always treat your phone and its accessories with care and keep them in a clean and dust-free place.
- Do not expose your phone or its accessories to open flames or lit tobacco products.
- Do not expose your phone or its accessories to liquid, moisture or high humidity.
- Do not drop, throw or try to bend your phone or its accessories.
- Do not use harsh chemicals, cleaning solvents, or aerosols to clean the device or its accessories.
- Do not paint your phone or its accessories.
- Do not attempt to disassemble your phone or its accessories, only authorized personnel must do so.
- Do not expose your phone or its accessories to extreme temperatures, minimum -4°F (-20°C) and maximum 122°F (50°C).
- Please check local regulations for disposal of electronic products.
- Do not carry your phone in your back pocket as it could break when you sit down.

- **Send the product for service.**

Unplug the product from the electrical outlet and refer servicing to an authorized service technician or provider under the following conditions:

- Liquid has been spilled or an object has fallen into the product.
- The product has been exposed to rain or water.
- The product has been dropped or damaged.
- There are noticeable signs of overheating.
- The product does not operate normally when you follow the operating instructions.

- **Avoid operating the product in hot areas.**

The product should be placed away from heat sources such as radiators, heat registers, stoves, or other products (including amplifiers) that produce heat.

- **Avoid operating the product in wet areas.**

Never use the product in a wet location.

● **Avoid using your device after a dramatic change in temperature.**

When you move your device between environments with very different temperature and/or humidity ranges, condensation may form on or within the device. To avoid damaging the device, allow sufficient time for the moisture to evaporate before using the device.

NOTICE: When taking the device from low-temperature conditions into a warmer environment or from high-temperature conditions into a cooler environment, allow the device to acclimate to room temperature before turning on power.

● **Avoid pushing objects into product.**

Never push objects of any kind into cabinet slots or other openings in the product. Slots and openings are provided for ventilation. These openings must not be blocked or covered.

● **Avoid placing device near air bags.**

Do not place a phone in the area over an air bag or in the air bag deployment area. Store the phone safely before driving your vehicle.

● **Use only manufacturer-approved mounting accessories.**

Do not use the product on an unstable table, cart, stand, tripod, or bracket. Any mounting of the product should follow the manufacturer's instructions, and should use a mounting accessory recommended by the manufacturer.

● **Avoid unstable mounting.**

Do not place the product with an unstable base.

● **Use only manufacturer-approved equipment.**

This product should be used only with personal computers and options identified as suitable for use with your equipment.

● **Adjust the volume before using headphones.**

Turn down the volume before using headphones or other audio devices.

● **Clean the product.**

Unplug the product from the wall outlet before cleaning. Do not use liquid cleaners or aerosol cleaners. Use a damp cloth for cleaning, but NEVER use water to clean the LCD screen.

● **Keep the product out of reach of small children.**

Do not leave your phone and its accessories within the reach of small children or allow them to play with it. They could hurt themselves or others, or could accidentally damage the phone. Your phone contains small parts with sharp edges that may cause an injury or which could become detached and create a choking hazard.

● **Avoid repetitive motion injuries.**

To minimise the risk of RSI, when Texting or playing games with your phone:

- Do not grip the phone too tightly
- Press the buttons lightly
- Make use of the special features in the handset which minimise the number of buttons which have to be pressed, such as message templates and predictive text.
- Take lots of breaks to stretch and relax.

● **Be attentive when operating machinery.**

Full attention must be given to operating the machinery in order to reduce the risk of an accident.

● **Electrostatic discharge (ESD) may damage the SIM card.**

Do not touch the SIM card's metal connectors.

● **Product produces loud noise.**

This phone is capable of producing loud noises which may damage your hearing.

● **Using the product during emergencies.**

This phone, like any wireless phone, operates using radio signals, which cannot guarantee connection in all conditions. Therefore, you must never rely solely on any wireless phone for emergency communications.

Additional Safety Information

Do Not Use the PC Functions of Your Device While Driving or Walking

Never use the personal computer functions of your device while driving an automobile or any other moving vehicle. Always pull out of traffic and come to a stop in a legally permissible and safe location before using your device. Failure to do so could result in serious bodily injury in a traffic accident.

When driving:

- Never place your device on the passenger seat or anyplace else in the car where it can become a projectile during a collision or stop.
- An air bag inflates with great force. DO NOT place objects, including either installed or portable wireless equipment, in the area over the air bag or in the air bag deployment area. If in-vehicle wireless equipment is improperly installed and the air bag inflates, serious injury could result.

Never store or transport flammable liquids, gases or explosive materials in the same compartment of your automobile as the device or any of its accessories, as possible sparking in the device could cause ignition or explosion.

Never use your device while walking. Usage while walking could result in bodily injury caused by inattention to automobile traffic or other pedestrian hazards.

Using The Phone While Driving Is Extremely Dangerous

Talking on or using your device while driving is extremely dangerous and is illegal in some states. Remember, safety comes first. Check the laws and regulations on the use of phones in the areas where you drive. Always obey them.

If you must use the phone function while driving, please:

- Give full attention to driving. Driving safely is your first responsibility.
- Use hands-free operation or one-touch, speed dialing, and auto answer modes.
- Pull off the road and park before making or answering a call.

WARNING: Failure to follow these instructions could lead to serious personal injury and possible property damage.

When Using Your Device Near Other Electronic Devices

Your wireless handheld portable device is a low power radio transmitter and receiver. When it is ON, it receives and also sends out radio frequency (RF) signals.

Most modern electronic equipment is shielded from RF energy. However, certain electronic equipment may not be shielded against the RF signals from your wireless device; therefore, use of your device must be restricted in certain situations.

In addition, the computer portion of your device produces low levels of RF energy due to the generation of digital timing pulses by its clock oscillator circuits. Your device has been equipped with internal shielding to minimize stray emissions of RF energy. However, use of the computer functions of your device must be restricted in certain situations.

Hearing Aids

Some digital wireless phones may interfere with some hearing aids. In the event of such interference, you may want to consult your service provider, or call the customer service line to discuss alternatives.

Electronic Devices in Vehicles

RF signals may affect improperly installed or inadequately shielded electronic systems in motor vehicles. Check with the manufacturer or its representative regarding your vehicle. You should also consult the manufacturer of any equipment that has been added to your vehicle.

Posted Facilities

Turn your device OFF where posted notices so require.

Turn Off Your Device Before Flying

Aircraft

FCC regulations prohibit using the transmitting and phone functions of your device while in the air. In addition, most airline regulations prohibit the on-board use of portable PCs (and all other portable electronic devices that could potentially emit stray RF energy), particularly during take-offs and landings, to prevent any possible interference with the reception of signals by airborne electronic navigational devices.

Turn your device OFF before boarding an aircraft. Always request and obtain prior consent and approval of an authorized airline representative before using your device aboard an aircraft. Always follow the instructions of the airline representative whenever using your device aboard an aircraft, to prevent any possible interference with airborne electronic equipment.

Turn Off Your Device in Dangerous Areas

Blasting Areas

To avoid interfering with blasting operations, turn your device OFF when in a “blasting area” or in areas posted “Turn off two-way radio.” Obey all signs and instructions.

Potentially Explosive Atmospheres

Turn your device OFF when in any area with a potentially explosive atmosphere and obey all signs and instructions. Sparks in such areas could cause an explosion or fire resulting in bodily injury or even death.

Areas with a potentially explosive atmosphere are often, but not always, clearly marked. They include fueling areas such as gas stations; below deck on boats; fuel or chemical transfer or storage facilities; vehicles using liquefied petroleum gas (such as propane or butane); areas where the air contains chemicals or articles, such as grain, dust, or metal powders; and any other area where you would normally be advised to turn off your vehicle's engine.

General Safety and Other Precautions

Your device is a high quality piece of equipment. Before operating, read all instructions and cautionary markings on the product, battery and AC phone charger.

Failure to follow the directions below could result in serious bodily injury or property damage due to battery liquid leakage, fire or rupture.

DO NOT use or store this equipment in a place where it will be exposed to high temperatures, such as near an open flame or heat-emitting equipment.

DO NOT drop your device or subject it to severe shock. When not using, lay down the unit to avoid possible damage due to instability.

DO NOT expose this equipment to rain or spilled beverages.

DO NOT use unauthorized accessories.

DO NOT disassemble the device or its accessories. If service or repair is required, return unit to an authorized Sprint service center. If the unit is disassembled, the risk of electric shock or fire may result.

Never allow metallic objects, such as staples and paper clips, to get into the inside of your device.

Never touch the liquid that might leak from a broken liquid crystal display. Contact with this liquid could cause a skin rash. If the crystal display liquid should come into contact with the skin or clothing, wash it immediately with clean water.

In the event that the device emits an unusual odor or sound or generates smoke, immediately disconnect the AC phone charger from the power outlet, and then detach the battery.

Antenna Safety

Use only the supplied or an approved replacement antenna. Unauthorized antennas, modifications, or attachments could impair call quality, damage your device, or result in violation of FCC regulations. Please contact your local dealer for replacement antenna.

Do not use the device with a damaged antenna. If a damaged antenna comes into contact with the skin, a minor burn may result. Please contact your local dealer for replacement antenna.

Battery Safety

Your device uses a removable and rechargeable lithium ion battery. Please contact customer service for assistance should you need a replacement battery.

DOs

- Only use the battery and charger approved by the manufacturer.
- Only use the battery for its original purpose.
- Try to keep batteries at a temperature between 41°F (5°C) and 95°F (35°C).
- If the battery is stored in temperatures above or below the recommended range, give it time to warm up or cool down before using.
- Completely drain the battery before recharging. It may take one to four days to completely drain.
- Store the discharged battery in a cool, dark, and dry place.
- Purchase a new battery when its operating time gradually decreases after fully charging.
- Properly dispose of the battery according to local regulations.

DON'Ts

- Don't attempt to disassemble the battery – it is a sealed unit with no serviceable parts.
- Don't expose the battery terminals to any other metal object (e.g., by carrying it in your pocket or purse with other metallic objects such as coins, clips and pens). This can short circuit and critically damage the battery.
- Don't leave the battery in hot or cold temps. Otherwise, it could significantly reduce the capacity and lifetime of the battery.
- Don't dispose of the battery into a fire.

Lithium ion batteries are recyclable. When you replace the removable battery, please request the repair center to recycle the battery in accordance with RBRC standards. When disposing of the battery by yourself, please call RBRC at (800) 822-8837 for proper disposal tips.

Never touch any fluid that might leak from the built-in battery. Such liquid when in contact with the eyes or skin, could cause injury to the skin or eyes. Should the liquid come into contact with the eyes, irrigate the eyes thoroughly with clean water and immediately seek medical attention. In the event the liquid comes into contact with the skin or clothing, wash it away immediately with clean water.

AC Phone Charger

Use the Correct External Power Source

A product should be operated only from the type of power source indicated on the electrical ratings label. If you are not sure of the type of power source required, consult your authorized service provider or local power company. For a product that operates from battery power or other sources, refer to the operating instructions that are included with the product.

The AC phone charger designed by Sprint for this unit requires the use of a standard 120 V AC power source for device operation.

Never attempt to disassemble or repair an AC phone charger. Never use an AC phone charger if it has a damaged or worn power cord or plug. Always contact a Sprint authorized service center, if repair or replacement is required.

Never alter the AC cord or plug on an AC phone charger. If the plug will not fit into the available outlet, have a proper outlet installed by a qualified electrician.

Never allow any liquids or water to spill on an AC phone charger when it is connected to an AC power source.

Always use the authorized Sprint AC phone charger to avoid any risk of bodily injury or damage to your cellular phone or battery.

Never attempt to connect or disconnect the AC phone charger with wet hands. Always unplug the AC phone charger from the power source before attempting any cleaning. Always use a soft cloth dampened with water to clean the equipment, after it has been unplugged.

Handling the cord on this product or cords associated with accessories sold with this product, will expose you to lead, a chemical known to the State of California to cause birth defects or other reproductive harm. Wash hands after handling.

Always disconnect the travel charger or desktop charger from the power source when it is not in use.

4B. Regulatory Notices

- ◆ Regulatory Agency Identifications (page 176)
- ◆ Federal Communication Commission Interference Statement (page 176)
- ◆ SAR Information (page 178)
- ◆ Telecommunications & Internet Association (TIA) Safety Information (page 179)
- ◆ WEEE Notice (page 180)
- ◆ RoHS Compliance (page 180)

This section provides more safety information and regulation statement for using your device.

Regulatory Agency Identifications

For regulatory identification purposes, your product is assigned a model number of **PC36100**.

To ensure continued reliable and safe operation of your device, use only the accessories listed below with your **PC36100**.

The Battery Pack has been assigned a model number of **RHOD160**.

Operating temperature range: 32°F to 104°F (0°C to 40°C)

Note: This product is intended for use with a certified Class 2 Limited Power Source, rated 5 Volts DC, maximum 1 Amp power supply unit.

Federal Communication Commission Interference Statement

This equipment has been tested and found to comply with the limits for a Class B digital device, pursuant to Part 15 of the FCC Rules. These limits are designed to provide reasonable protection against harmful interference in a residential installation. This equipment generates, uses and can radiate radio frequency energy and, if not installed and used in accordance with the instructions, may cause harmful interference to radio communications. However, there is no guarantee that interference will not occur in a particular installation. If this equipment does cause harmful interference to radio or television reception, which can be determined by turning the equipment off and on, the user is encouraged to try to correct the interference by one of the following measures:

- Reorient or relocate the receiving antenna.
- Increase the separation between the equipment and receiver.
- Connect the equipment into an outlet on a circuit different from that to which the receiver is connected.
- Consult the dealer or an experienced radio or television technician for help.

FCC Caution: Any changes or modifications not expressly approved by the party responsible for compliance could void the user's authority to operate this equipment.

This device complies with Part 15 of the FCC Rules. Operation is subject to the following two conditions: (1) This device may not cause harmful interference, and (2) this device must accept any interference received, including interference that may cause undesired operation.

Important Note

Radiation Exposure Statement:

This equipment complies with FCC radiation exposure limits set forth for an uncontrolled environment. End users must follow the specific operating instructions for satisfying RF exposure compliance. To maintain compliance with FCC RF exposure compliance requirements, please follow operation instruction as documented in this manual.

This transmitter must not be co-located or operating in conjunction with any other antenna or transmitter, except the transmitters built-in with the device.

FCC Hearing-Aid Compatibility (HAC) Regulations for Wireless Devices

On July 10, 2003, the U.S. Federal Communications Commission (FCC) Report and Order in WT Docket 01-309 modified the exception of wireless phones under the Hearing Aid Compatibility Act of 1988 (HAC Act) to require digital wireless phones be compatible with hearing-aids. The intent of the HAC Act is to ensure reasonable access to telecommunications services for persons with hearing disabilities. While some wireless phones are used near some hearing devices (hearing aids and cochlear implants), users may detect a buzzing, humming, or whining noise. Some hearing devices are more immune than others to this interference noise, and phones also vary in the amount of interference they generate. The wireless telephone industry has developed a rating system for wireless phones, to assist hearing device users find phones that may be compatible with their hearing devices. Not all phones have been rated. Phones that are rated have the rating on their box or a label located on the box. The ratings are not guarantees. Results will vary depending on the user's hearing device and hearing loss. If your hearing device happens to be vulnerable to interference, you may not be able to use a rated phone successfully. Trying out the phone with your hearing device is the best way to evaluate it for your personal needs.

M-Ratings: Phones rated M3 or M4 meet FCC requirements and are likely to generate less interference to hearing devices than phones that are not rated. M4 is the better/higher of the two ratings. Your HTC EVO™ 4G is rated M3.

T-Ratings: Phones rated T3 or T4 meet FCC requirements and are likely to be more usable with a hearing aid's telecoil than phones that are not rated. T4 is the better/higher of the two ratings. Your HTC EVO™ 4G is rated T3.

Please power off the Bluetooth function while using hearing aid devices with your HTC EVO™ 4G.

Hearing devices may also be rated. Your hearing device manufacturer or hearing health professional may help you find this rating. Higher ratings mean that the hearing device is relatively immune to interference noise.

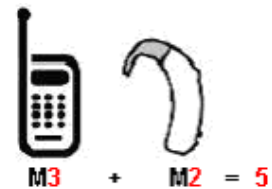

The hearing aid and wireless phone rating values are then added together. A sum of 5 is considered acceptable for normal use. A sum of 6 is considered for better use. A sum of 8 is considered for best use. In the above example, if a hearing aid meets the M2 level rating and the wireless phone meets the M3 level rating, the sum of the two values equal M5. This should provide the hearing aid user with “normal usage” while using their hearing aid with the particular wireless phone. “Normal usage” in this context is defined as a signal quality that is acceptable for normal operation.

This methodology applies equally for T ratings. The M mark is intended to be synonymous with the U mark. The T mark is intended to be synonymous with the UT mark. The M and T marks are recommended by the Alliance for Telecommunications Industries Solutions (ATIS). The U and UT marks are referenced in Section 20.19 of the FCC Rules. The HAC rating and measurement procedure are described in the American National Standards Institute (ANSI) C63.19 standard.

For information about hearing aids and digital wireless phones

FCC Hearing Aid Compatibility and Volume Control:

<http://www.fcc.gov/cgb/dro/hearing.html>

Gallaudet University, RERC:

<https://fjallfoss.fcc.gov/oetcf/eas/reports/GenericSearch.cfm>

SAR Information

1.03 W/kg @ 1g (HEAD)

0.961 W/kg @ 1g (BODY)

THIS MODEL DEVICE MEETS THE GOVERNMENT'S REQUIREMENTS FOR EXPOSURE TO RADIO WAVES. For body worn operation, this phone has been tested and meets the FCC RF exposure guidelines when used with the HTC Corporation. Accessories supplied or designated for this product. Use of other accessories may not ensure compliance with the FCC RF exposure guidelines.

Your wireless mobile phone is a radio transmitter and receiver. It is designed and manufactured not to exceed the emission limits for exposure to radio frequency (RF) energy set by the Federal Communications Commission of the U.S. Government. These limits are part of comprehensive guidelines and establish permitted levels of RF energy for the general population. The guidelines are based on the safety standards previously set by both U.S. and international standards bodies:

- American National Standards Institute (ANSI) IEEE. C95.1-1992.
- National Council on Radiation Protection and Measurement (NCRP). Report 86. 1986.
- International Commission on Non-Ionizing Radiation Protection (ICNIRP) 1996.
- Ministry of Health (Canada), Safety Code 6. The standards include a substantial safety margin designed to assure the safety of all persons, regardless of age and health.

The exposure standard for wireless mobile phone employs a unit of measurement known as the Specific Absorption Rate, or SAR. The SAR limit set by the FCC is 1.6 W/kg¹.

The FCC has granted an Equipment Authorization for this model device with all reported SAR levels evaluated as in compliance with the FCC RF exposure guidelines. SAR information on this model device is on file with the FCC and can be found under the Display Grant section of

<https://fjallfoss.fcc.gov/oetcf/eas/reports/GenericSearch.cfm> after searching on FCC ID: NM8PC36100.

Additional information on Specific Absorption Rates (SAR) can be found on the Cellular Telecommunications & Internet Association (CTIA) website as <http://www.phonefacts.net>.

¹In the U.S. and Canada, the SAR limit for mobile phone used by the public is 1.6 Watts/kg (W/kg) averaged over one gram of tissue. The standard incorporates a substantial margin of safety to give additional protection for the public and to account for any variations in usage. Normal condition only to ensure the radiative performance and safety of the interference. As with other mobile radio transmitting equipment, users are advised that for satisfactory operation of the equipment and for the safety of personnel, it is recommended that no part of the human body be allowed to come too close to the antenna during operation of the equipment.

Body-worn Operation

This device was tested for typical body-worn operations. To comply with RF exposure requirements, a minimum separation distance of 1.5 cm must be maintained between the user's body and the handset, including the antenna. Third-party belt-clips, holsters, and similar accessories used by this device should not contain any metallic components. Body-worn accessories that do not meet these requirements may not comply with RF exposure requirements and should be avoided.

Use only the supplied or an approved antenna. Unauthorized antennas, modifications, or attachments could impair call quality, damage the phone, or result in violation of regulations. Do not use the phone with a damaged antenna. If a damaged antenna comes into contact with the skin, a minor burn may result. Please contact your local dealer for replacement antenna.

Telecommunications & Internet Association (TIA) Safety Information

Pacemakers

The Health Industry Manufacturers Association recommends that a minimum separation of six inches be maintained between a handheld wireless phone and a pacemaker to avoid potential interference with the pacemaker. These recommendations are consistent with the independent research by and recommendations of Wireless Technology Research. Persons with pacemakers:

- Should ALWAYS keep the phone more than six inches from their pacemaker when the phone is turned ON.
- Should not carry the phone in a breast pocket.
- Should use the ear opposite the pacemaker to minimize the potential for interference. If you have any reason to suspect that interference is taking place, turn the phone OFF immediately.

Hearing Aids

Some digital wireless phones may interfere with some hearing aids. In the event of such interference, you may want to consult your service provider, or call the customer service line to discuss alternatives.

Other Medical Devices

If you use any other personal medical device, consult the manufacturer of your device to determine if they are adequately shielded from external RF energy. Your physician may be able to assist you in obtaining this information.

Turn the phone OFF in health care facilities when any regulations posted in these areas instruct you to do so. Hospitals or health care facilities may be using equipment that could be sensitive to external RF energy.

WEEE Notice

The Directive on Waste Electrical and Electronic Equipment (WEEE), which entered into force as European law on 13th February 2003, resulted in a major change in the treatment of electrical equipment at end-of-life.

The purpose of this Directive is, as a first priority, the prevention of WEEE, and in addition, to promote the reuse, recycling and other forms of recovery of such wastes so as to reduce disposal.



The WEEE logo (shown at the left) on the product or on its box indicates that this product must not be disposed of or dumped with your other household waste. You are liable to dispose of all your electronic or electrical waste equipment by relocating over to the specified collection point for recycling of such hazardous waste. Isolated collection and proper recovery of your electronic and electrical waste equipment at the time of disposal will allow us to help conserving natural resources. Moreover, proper recycling of the electronic and electrical waste equipment will ensure safety of human health and environment. For more information about electronic and electrical waste equipment disposal, recovery, and collection points, please contact your local city center, household waste disposal service, shop from where you purchased the equipment, or manufacturer of the equipment.

RoHS Compliance

This product is in compliance with Directive 2002/95/EC of the European Parliament and of the Council of 27 January 2003, on the restriction of the use of certain hazardous substances in electrical and electronic equipment (RoHS) and its amendments.

4C. Manufacturer's Warranty

- ◆ Manufacturer's Warranty (page 181)
- ◆ Privacy Restrictions (page 182)
- ◆ Weather Disclaimer (page 183)
- ◆ Warranty Disclaimer (page 183)
- ◆ Limitation of Damages (page 183)

Your device has been designed to provide you with reliable, worry-free service. If for any reason you have a problem with your equipment, please refer to the manufacturer's warranty in this section.

For information regarding the terms and conditions of service for your device, please visit www.sprint.com or call Sprint Customer Service at **1-888-211-4727**.

Note: In addition to the warranty provided by your device's manufacturer, which is detailed on the following pages, Sprint offers a number of optional plans to cover your equipment for non-warranty claims. **Sprint Total Equipment Protection** provides the combined coverage of the **Sprint Equipment Replacement Program** and the **Sprint Equipment Service and Repair Program**, both of which are available separately. Each of these programs may be signed up for within 30 days of activating your device. For more details, please visit your nearest Sprint Store or call Sprint at **1-800-584-3666**.

Manufacturer's Warranty

12 Month Limited Warranty

HTC Corporation (the Company) warrants to the original retail purchaser of this HTC handheld portable cellular telephone, that should this product or any part thereof during normal consumer usage and conditions, be proven defective in material or workmanship that results in product failure within the first twelve (12) month period from the date of purchase, such defect(s) will be repaired or replaced (with new or rebuilt parts) at the Company's option, without charge for parts or labor directly related to the defect(s).

The antenna, keypad, display, rechargeable battery and battery charger, if included, are similarly warranted for twelve (12) months from date of purchase.

This Warranty extends only to consumers who purchase the product in the United States or Canada and it is not transferable or assignable.

This Warranty does not apply to:

- Product subjected to abnormal use or conditions, accident, mishandling, neglect, unauthorized alteration, misuse, improper installation or repair or improper storage;
- Product whose mechanical serial number or electronic serial number has been removed, altered or defaced;
- Damage from exposure to moisture, humidity, excessive temperatures or extreme environmental conditions;
- Damage resulting from connection to, or use of any accessory or other product not approved or authorized by the Company;
- Defects in appearance, cosmetic, decorative or structural items such as framing and non-operative parts;
- Product damaged from external causes such as fire, flooding, dirt, sand, weather conditions, battery leakage, blown fuse, theft or improper usage of any electrical source.

The Company disclaims liability for removal or reinstallation of the product, for geographic coverage, for inadequate signal reception by the antenna or for communications range or operation of the cellular system as a whole.

Before sending your wireless device to HTC Corporation for repair or service, please note that any personal data or software stored on the device may be inadvertently erased or altered. Therefore, we strongly recommend you make a back up copy of all data and software contained on your device before submitting it for repair or service. This includes all contact lists, downloads (i.e. third-party software applications, ring tones, games and graphics) and any other data added to your device. In addition, if your wireless device utilizes a SIM or Multimedia card, please remove the card before submitting the device and store for later use when your device is returned, HTC Corporation is not responsible for and does not guarantee restoration of any third-party software, personal information or memory data contained in, stored on, or integrated with any wireless device, whether under warranty or not, returned to HTC Corporation for repair or service.

To obtain repairs or replacement within the terms of this Warranty, the product should be delivered with proof of Warranty coverage (e.g. dated bill of sale), the consumer's return address, daytime phone number or fax number and complete description of the problem, transportation prepaid. Please follow the steps at www.htc.com/us/support or return to the place of purchase for repair or replacement processing. In addition, for reference to an authorized Warranty station in your area, you may telephone in the United States +1(866) 449-8358.

THE EXTENT OF THE COMPANY'S LIABILITY UNDER THIS WARRANTY IS LIMITED TO THE REPAIR OR REPLACEMENT PROVIDED ABOVE AND, IN NO EVENT, SHALL THE COMPANY'S LIABILITY EXCEED THE PURCHASE PRICE PAID BY PURCHASER FOR THE PRODUCT.

ANY IMPLIED WARRANTIES, INCLUDING ANY IMPLIED WARRANTY OF MERCHANTABILITY OR FITNESS FOR A PARTICULAR PURPOSE, SHALL BE LIMITED TO THE DURATION OF THIS WRITTEN WARRANTY. ANY ACTION FOR BREACH OF ANY WARRANTY MUST BE BROUGHT WITHIN A PERIOD OF 18 MONTHS FROM DATE OF ORIGINAL PURCHASE. IN NO CASE SHALL THE COMPANY BE LIABLE FOR AN SPECIAL CONSEQUENTIAL OR INCIDENTAL DAMAGES FOR BREACH OF THIS OR ANY OTHER WARRANTY, EXPRESS OR IMPLIED, WHATSOEVER. THE COMPANY SHALL NOT BE LIABLE FOR THE DELAY IN RENDERING SERVICE UNDER THIS WARRANTY OR LOSS OF USE DURING THE TIME THE PRODUCT IS BEING REPAIRED OR REPLACED.

No person or representative is authorized to assume for the Company any liability other than expressed herein in connection with the sale of this product.

Some states or provinces do not allow limitations on how long an implied warranty lasts or the exclusion or limitation of incidental or consequential damage so the above limitation or exclusions may not apply to you. This Warranty gives you specific legal rights, and you may also have other rights, which vary from state to state.

IN USA AND CANADA: Please go to www.htc.com/us/support

Privacy Restrictions

Some countries require full disclosure of recorded telephone conversations, and stipulate that you must inform the person with whom you are speaking that the conversation is being recorded. Always obey the relevant laws and regulations of your country when using the recording feature of your device.

Weather Disclaimer

ANY WEATHER, STOCK, OR OTHER INFORMATION, DATA, OR DOCUMENTATION (“ACCESSED INFORMATION”) ARE PROVIDED “AS IS” AND WITHOUT ANY WARRANTY OR ANY TECHNICAL SUPPORT. TO THE MAXIMUM EXTENT PERMITTED BY APPLICABLE LAW, HTC AND ITS AFFILIATES expressly disclaim any and all representations and warranties, arising by law or otherwise, related to the Accessed Information, including without limitation any express or implied representation or warranty of merchantability, fitness for a particular purpose, non-infringement, quality, accuracy, completeness, effectiveness, reliability, or usefulness. Without limiting the foregoing, it is further understood that HTC and its Affiliates are not responsible for any use or of the Accessed Information or the results arising from such use, and that you use such information at your own risk.

Warranty Disclaimer

Your warranty is invalidated if you open or tamper with the device's outer casing.

For details about warranty coverage, see “Manufacturer’s Warranty” on page 181.

Limitation of Damages

TO THE MAXIMUM EXTENT PERMITTED BY APPLICABLE LAW, IN NO EVENT SHALL HTC OR ITS AFFILIATES BE LIABLE TO YOU, ANY USER, OR THIRD PARTY FOR ANY INDIRECT, SPECIAL, CONSEQUENTIAL, INCIDENTAL OR PUNITIVE DAMAGES OF ANY KIND, ARISING IN CONTRACT, TORT, OR OTHERWISE, INCLUDING, BUT NOT LIMITED TO, INJURY, LOSS OF REVENUE, LOSS OF GOODWILL, LOSS OF BUSINESS OPPORTUNITY, LOSS OF DATA, AND/OR LOSS OF PROFITS, REGARDLESS OF THE FORESEEABILITY THEREOF OR WHETHER HTC OR ITS AFFILIATES HAVE BEEN ADVISED OF THE POSSIBILITY OF SUCH DAMAGES. AND IN NO EVENT SHALL THE TOTAL LIABILITY OF HTC OR ITS AFFILIATES EXCEED THE AMOUNT RECEIVED FROM YOU, REGARDLESS OF THE LEGAL THEORY UNDER WHICH THE CAUSE OF ACTION IS BROUGHT. THE FOREGOING DOES NOT AFFECT ANY STATUTORY RIGHTS WHICH MAY NOT BE DISCLAIMED.

4D. Copyright, Trademark, and Proprietary Notices

©2010 Sprint. SPRINT and the logo are trademarks of Sprint. Other marks are the property of their respective owners.

HTC, the HTC logo, HTC Innovation, ExtUSB, HTC Sense, HTC Peep, Footprints, HTC Sync, and HTC Care are trademarks or service marks of HTC Corporation.

Copyright © 2010 Google Inc. Used with permission.

Google, the Google logo, Android, the Android logo, Android Market, the Android Market logo, Gmail, Google Apps, Google Calendar, Google Checkout, Google Earth, Google Latitude, Google Maps, Google Talk, Picasa, and YouTube are trademarks of Google Inc.

Google, the Google logo and Google Maps are trademarks of Google, Inc. TeleAtlas® Map Data ©2010. Street View Images ©2010 Google.

Microsoft, Windows, Windows XP, Windows Vista, Word, Excel, PowerPoint, and Outlook are either registered trademarks or trademarks of Microsoft Corporation in the United States or other countries.

Bluetooth and the Bluetooth logo are trademarks owned by Bluetooth SIG, Inc.

Wi-Fi is a registered trademark of the Wireless Fidelity Alliance, Inc.

microSD is a trademark of SD Card Association.

Java, J2ME and all other Java-based marks are trademarks or registered trademarks of Sun Microsystems, Inc. in the United States and other countries.

This HTC EVO™ 4G contains Adobe® Flash® Player software under license from Adobe Systems Incorporated, Copyright © 1995-2010 Adobe Macromedia Software LLC

Licensed by QUALCOMM Incorporated under one or more of the following patents:

4,901,307 5,490,165 5,056,109 5,504,773 5,101,501 5,778,338 5,506,865 5,109,390 5,511,073 5,22 8,054
5,535,239 5,710,784 5,267,261 5,544,196 5,267,262 5,568,483 5,33 7,33 8 5,659,569 5,600,754 5,414,796
5,657,420 5,416,797

All other company, product and service names mentioned herein are trademarks, registered trademarks or service marks of their respective owners.

Index

Numerics

- 1xRTT 114
- 3G 114
- 3-Way Call 108
- 4G 113
 - Data Transfer Rates 113

A

- Activation 2
- Airplane Mode 32
- Alarm Clock 62
- Amazon MP3 150
- Android Market 136
- Answering Calls 16
- Automatic Speech Recognition (ASR) 69

B

- Backing Up 48
- Battery 12–13
 - Capacity 12
 - Charging 13
 - Installing 12
- Bluetooth 94
- Bluetooth Headset 94
- Browser 116
 - Browser Menu 116
 - Finding Text 118
 - Managing Bookmarks 121
 - Screen Orientation 117
 - Selecting Links 119
 - Zooming In or Out 118

C

- Calculator 59
- Calendar 54
 - Adding an Event 54
 - Erasing Events 58
 - Event Alert Menu 55
 - Meeting Request 55
 - Sending Invites 55
- Calendars
 - Showing or Hiding Events 58
 - Synchronizing Google Calendars 58
- Call Forwarding 108
- Call Guard 110
- Call Waiting 108
- Caller ID 108
- Camera 75
 - Camera Flash 78
 - Face Detection 77
 - Opening 75
 - Review Screen 76
 - Settings 79
 - Taking Pictures 77
 - Videos 78
 - Viewfinder Screen 75
- Car Kit 94
- Changing 135
- Clock 59

D

- Data Roam Guard 110
- Data Services 114–147
 - see also Web
 - Enabling and Disabling 34
 - FAQs 147
 - Launching the Web 114
 - Password 3
 - Security Features 34
 - User Name 114
- Desk Clock 60
- Device (illus.) 6
- Device Basics 2, 6
- Device Settings 26
 - Airplane Mode 32
 - Application Settings 36
 - Data Synchronization Settings 34
 - Date & Time Settings 37
 - Display Settings 29
 - Locale & Text Settings 37
 - Location Settings 30
 - Messaging Settings 31
 - Personalization Settings 26
 - Security Settings 33
 - Sound Settings 27
 - TTY Use 32
- Device Updates 68
- Display Screen 9, 29

E

- Email 122
 - Account Settings 126
 - Composing and Sending 123
 - Creating Accounts 123
 - Deleting Accounts 126
 - Deleting Messages 125
 - Exchange ActiveSync 122
 - Managing the Inbox 124
 - Refreshing the Inbox 124
 - Sorting Messages 124
 - Viewing and Replying 123
- Emergency Numbers 17
- End-of-Call Options 18
- Enhanced 911 (E911) 17
- Entering Text 19
- Event Alert Menu 55
- Exchange ActiveSync
 - Features 125
 - Flagging Messages 125
 - Meeting Request 125
 - Message Priority 126
 - Out of the Office Reply 125
 - Synchronizing 125

F

- Face Detection 77
- Facebook
 - Facebook for HTC Sense 50
 - FAQ 52
 - For Android 51
 - Logging In 35
 - Synchronizing 36

- Flash 78
 - FAQ 78
- Flickr
 - Logging In 35
- FM Radio 92
 - Adding Station Names 93
 - Minimizing or Turning Off 93
 - Tuning to a Station 92
- Footprints 163
- Friend Stream 52
- G**
 - Getting Around Your Device 13
 - Gmail 126
 - Conversations and Email 130
 - Creating and Sending Email 127
 - Labeling a Conversation 130
 - Muting a Conversation 129
 - Receiving and Reading Email 128
 - Replying to or Forwarding Email 129
 - Reporting Spam 129
 - Searching Messages 130
 - Settings 131
 - Starring a Message 130
 - Synchronization Settings 130
 - Google Latitude 160
 - Google Maps 156
 - Google Talk 131
 - Changing Online Status and Picture 133
 - Chatting 132
 - Managing the Friends List 133
 - Settings 135
 - GPS Navigation 155
 - GPS Services 155
- H**
 - HDMI
 - Viewing Photos and Videos 84
 - HDMI Jack 84
 - History 39
 - Erasing 40
 - Making a Call 39
 - Prepending a Number 40
 - Saving a Number 40
 - Home Screen 22
 - Customizing 23
 - Extended 23
 - HTC Sync 65
- I**
 - Importing Entries 48
 - In-Call Options 17
 - Installing HTC Sync 65
 - Internet
 - Connecting 111
 - see Web
- K**
 - Key Functions 7
- L**
 - Location Settings 30
- M**
 - Mail
 - Mail Widget 126
 - Making Calls 15
 - From Text Message 15
 - Using the Dialer 15
 - Menu i
 - Messaging
 - Deleting Old Messages 31
 - Email 122
 - Multimedia Messaging (MMS) 102
 - Notification 31
 - Preset Messages 31
 - Text Messaging 102
 - Voice mail 100
 - microSD Card 72
 - Using as a USB Drive 74
 - Missed Calls 17
 - Multimedia Messaging (MMS) 102
 - Music 88
 - Playing Music 88, 150
 - Streaming Music 150
- N**
 - NASCAR Sprint Cup Mobile 152
 - Navigation, GPS 155
 - News 143
 - News Screen 143
 - Notifications Panel 11
- O**
 - Onscreen Keyboard 19
 - Compact QWERTY 20
 - Entering Text 20
 - Phone Keypad 20
 - QWERTY 20
- P**
 - PDF Viewer 64
 - Peep 138
 - People 18, 41
 - Adding a Number 45
 - Adding an Entry 43
 - Assigning a Picture 46
 - Assigning Ringers 46
 - Contact Details Screen 44
 - Editing and Entry 45
 - Finding Entries 47
 - My Contact Card 42
 - Saving a Phone Number 44
 - People Widget 49
 - Using 49
 - Phone Number
 - Displaying 14
 - Finding 18
 - Saving 18, 44
 - Photos
 - Using 81
 - Viewing Pictures and Videos 81
 - Picture Messaging
 - see Multimedia Messaging
 - Pictures and Videos 75
 - Playing Music 150

- POP3/IMAP Email
 - Adding 122
 - Preset Messages 31, 103
- Q**
 - Qik 88
 - Closing 88
 - Closing the application 88
 - Sharing Live Videos 88
 - Quickoffice 63
 - Viewing files 63
- R**
 - Resetting Your Device 34
 - Ringers
 - Assigning to contacts 46
 - Setting for Voice Calls 27
 - Silence All 28
 - Types 27
 - Vibrate 28
 - Roaming 109
 - Call Guard 110
 - Data Roam Guard 110
 - Roam Mode 109
- S**
 - Saving a Phone Number 18, 44
 - Scenes
 - Customizing 25
 - Security
 - Data Services 34
 - Silence All 28
 - Sleep Mode 8
 - SMS Text Messaging 102
 - Social Networks 50
 - Software Updates
 - Downloading 68
 - Spam 129
 - Email 129
 - Speed Dial
 - Assigning Numbers 19
 - Sprint 4G 113
 - Connecting 113
 - Turning On 113
 - Sprint Navigation 155
 - Sprint Service
 - Account Passwords 3
 - Activation 2
 - Dialing Sprint Services 19
 - Operator Services 4
 - Sprint 411 4
 - Sprint TV 148
 - Stocks 140
 - Streaming Music 150
- T**
 - Text Messaging 102
 - Preset Messages 103
 - Three-Way Calling 108
 - TTY Use 32
 - Turning Your Device On and Off 8
 - TV 148
- Twitter
 - Logging In 35
 - Synchronizing 36
- U**
 - Updating Your Device 68
- V**
 - Vibrate 28
 - Videos
 - Capturing 78
 - Voice Dialing 69
 - Voice Memos 70
 - Voicemail
 - Clear Icon 101
 - Notification 100
 - Retrieving 101
 - Setting Up 3, 100
 - Volume 27
- W**
 - Warranty 181
 - Weather 141
 - Web 114–147
 - see also Data Services
 - Email 122
 - Launching 114
 - User Name 114
 - Widgets 24
 - Working with Groups 48
 - World Clock 61
- Y**
 - YouTube 151
- Z**
 - Zooming 76